



Part #	Prepared By
Project	Date
Type	

4"X12" Luxify™ Cylinder

Flush Lensed LED 700-3000 Lumens



Features & Construction

ELECTRICAL SYSTEM

- 700 - 3000 Lumens
- 2700K - 4000K CCT
- 80 CRI with 3 SDCM color consistency, 90+ CRI available
- Standard 0-10V 10% dimming driver (SDM), 1% dimming driver optional
- 120V - 277V Universal Input Volts
- Minimum 50,000 hour lifetime at L70
- -20°C to 30°C Ambient Operating Temperature Range

OPTICS

- Frosted polycarbonate lens for even, smooth distribution
- Distribution is free of streaks, striations and hotspots
- 15° Narrow, 30° Medium and 45° Wide distributions

HOUSING & MOUNTING

- .064" thick spun aluminum cylinder
- Powder coat paint with standard finishes of white, black, bronze, silver or custom color
- Heatsink - Integrated aluminum heat sink for superior thermal management.
- 4 mounting solutions, Ceiling/Surface, Wall, Cord & Cable and Pendant mount
- Pendant Mount - 1/8" IP x 12" long rigid stem with a 45° swivel canopy for sloped ceiling applications.
- Cord & Cable Mount - 72" cord provided standard

Listings

- ETL certified to UL1598 and UL8750 requirements
- Tested according to LM-79 and LM-80 standards
- Suitable for damp locations; Wet location under covered ceiling (per NEC 410 & UL 1598)
- Buy American Act (BAA)

Warranty & Notes

- 5-year limited warranty on LED module and driver
- www.vantageltg.com/product-warranty
- Photometric tests performed by an accredited NVLP facility and in accordance to IESNA LM-79-2008 testing procedures

Lumens*

Nominal Lumens	Wattage	NW Delivered Lumens	LPW	MD Delivered Lumens	LPW	WE Delivered Lumens	LPW
700	7.61	697	91.59	696	91.46	700	91.98
1300	14.13	1295	91.65	1292	91.44	1299	91.93
2000	21.74	1992	91.63	1988	91.44	1999	21.74
3000	33.72	2987	88.58	2982	88.43	2999	88.94

Measured at 4000K with NW, MD and WE distributions. *Actual Wattage/Lumens may vary.

Ordering Information

EXAMPLE: VC412EBLEDU-2035K-BLK-WE-ZDM-P-24

Mounting Options	Series	Voltage	Lumens	Kelvin (CCT)	Housing Finish	Reflector	Driver* Options	Additional Options*
VC Ceiling Mount VP Pendant Mount VW Wall Mount	412EBLED	U - 120V-277V 1 - 120V 2 - 277V *Must provide voltage when optional drivers are selected.	07 - 700 13 - 1300 20 - 2000 30 - 3000* *Driver In Canopy	27K - 2700K 30K - 3000K 35K - 3500K 40K - 4000K	WHT White Matte BLK Black Matte BZ Bronze CS Silver CC Custom RAL Color	NW 15° Narrow MD 20° Medium WE 40° Wide	SDM (Standard) ZDM DTD TDM DMX DL-2 DL-3 LDE1 PEQ0	HCR REM DCA P-"xx" CH272TK CCK-"xx" CK-"xx" FCJS-ECO FCJS-010 FCJS-ECO-EM FCJS-010-EM FC-SENSOR FC-VSENSOR

*Driver Options Notes

- SDM - 0-10V 10% dimming driver (standard)
- ZDM - 0-10V 1% dimming driver
- TDM - Triac (Forward Phase, 120V only) dimming driver.
- DTD - 0-10V 0.1% Dim-To-Dark dimming driver.
- DMX - DMX with RDM dimming driver, requires DCA
- DL-2 - Lutron 2-Wire Hi-Lume dimming driver.
- DL-3 - Lutron Hi-Lume 1% 3-wire dimming driver.
- LDE1 - Lutron Hi-Lume 1% with Soft-On, Fade-to-Black dimming driver.
- PEQ0 - Lutron Hi-Lume Premier 0.1% with Soft-On, Fade-to-Black dimming driver.

*Additional Options Notes

- HCR - High CRI, 90+ minimum
- REM - Remote Battery Backup W/remote Test Button And Indicator Light
- P-"XX" - Specify length of Pendant Mount (if specified pendant length is not within 12" increments, a CH272TK is required)
- DCA - DMX Daisy Chain Adaptor. Must be included with DMX option.
- CH272TK - Field Cut Kit For Stems (needed for pendant lengths not within a 12" increment)
- CCK-"XX" - Specify length of Cord & Cable Kit
- CK-"XX" - Specify length of Cord Kit
- FCJS-ECO - Vive PowPak EcoSystem Control Module
- FCJS-010 - Vive PowPak 0-10 V Control Module, 1 A Switched
- FCJS-ECO-EM - Emergency rated Vive PowPak EcoSystem Control Module
- FCJS-010-EM - Emergency rated Vive PowPak 0-10 V Control Module, 1 A Switched
- FC-SENSOR - Combo Occupancy & Daylight Sensor, Wired (used only with FCJS-ECO and FCJS-010 modules)
- FC-VSENSOR - Combo Vacancy & Daylight Sensor, Wired (used only with FCJS-ECO and FCJS-010 modules)

4"X12" Luxify™ Cylinder

Flush Lensed LED 700-3000 Lumens



PHOTOMETRY

Narrow 15° - NW

Model
412EBLED-3040K-NW

Lumens
2987

Watts
33.72

Efficacy
88.58

SC
0.25

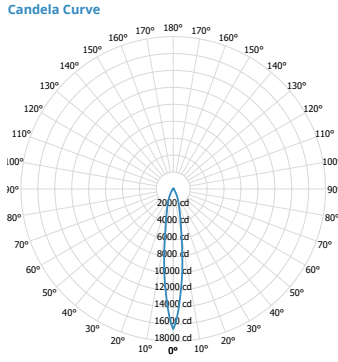

Mounting Height AFF	FC at Center on Floor	Beam Diameter
8.0 ft	258 fc	2.1 ft
10.0 ft	165 fc	2.7 ft
12.0 ft	115 fc	3.2 ft
14.0 ft	84 fc	3.7 ft
16.0 ft	65 fc	4.3 ft
20.0 ft	41 fc	5.4 ft
24.0 ft	29 fc	6.4 ft
30.0 ft	18 fc	8.0 ft

Candela Table	0.00°
0.00°	16540
5.00°	11202
10.00°	5606
15.00°	3040
20.00°	1911
30.00°	694
40.00°	243
50.00°	112
60.00°	66
70.00°	42
80.00°	21
90.00°	13

Zonal Lumen Summary	Zone	Lumens	% Luminaire
0° - 30°	2334	78%	
0° - 40°	2597	87%	
0° - 60°	2801	94%	
60° - 90°	98	3%	
0° - 20°	1778	60%	
20° - 50°	947	32%	
50° - 70°	126	4%	
70° - 90°	48	2%	
0° - 90°	2899	97%	
90° - 180°	89	3%	
Total	2987	100%	

Spacing Criterion	Height	Spacing	Light Level*
8 ft	2.0 ft	~ 258 fc	
10 ft	2.5 ft	~ 165 fc	
12 ft	3.0 ft	~ 115 fc	
8 ft	1.5 ft	~ 459 fc	
10 ft	1.9 ft	~ 294 fc	
12 ft	2.3 ft	~ 204 fc	
8 ft	1.0 ft	~ 1034 fc	
10 ft	1.3 ft	~ 662 fc	
12 ft	1.5 ft	~ 459 fc	

* approximate direct light level at floor based on spacing criterion overlap

Medium 20° - MD

Model
412EBLED-3040K-MD

Lumens
2982

Watts
33.72

Efficacy
88.43

SC
0.36

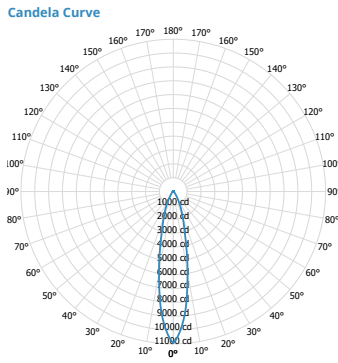

Mounting Height AFF	FC at Center on Floor	Beam Diameter
8.0 ft	171 fc	3.1 ft
10.0 ft	109 fc	3.9 ft
12.0 ft	76 fc	4.6 ft
14.0 ft	56 fc	5.4 ft
16.0 ft	43 fc	6.2 ft
20.0 ft	27 fc	7.7 ft
24.0 ft	19 fc	9.2 ft
30.0 ft	12 fc	11.6 ft

Candela Table	0.00°
0.00°	10938
5.00°	9085
10.00°	5935
15.00°	3341
20.00°	2027
30.00°	697
40.00°	244
50.00°	119
60.00°	72
70.00°	46
80.00°	23
90.00°	13

Zonal Lumen Summary	Zone	Lumens	% Luminaire
0° - 30°	2304	77%	
0° - 40°	2567	86%	
0° - 60°	2781	93%	
60° - 90°	107	4%	
0° - 20°	1728	58%	
20° - 50°	970	33%	
50° - 70°	137	5%	
70° - 90°	52	2%	
0° - 90°	2888	97%	
90° - 180°	95	3%	
Total	2982	100%	

Spacing Criterion	Height	Spacing	Light Level*
8 ft	2.9 ft	~ 171 fc	
10 ft	3.6 ft	~ 109 fc	
12 ft	4.3 ft	~ 76 fc	
8 ft	2.2 ft	~ 304 fc	
10 ft	2.7 ft	~ 194 fc	
12 ft	3.2 ft	~ 135 fc	
8 ft	1.4 ft	~ 684 fc	
10 ft	1.8 ft	~ 438 fc	
12 ft	2.2 ft	~ 304 fc	

* approximate direct light level at floor based on spacing criterion overlap

Wide 40° - WE

Model
412EBLED-3040K-MD

Lumens
2999

Watts
33.72

Efficacy
88.94

SC
0.67

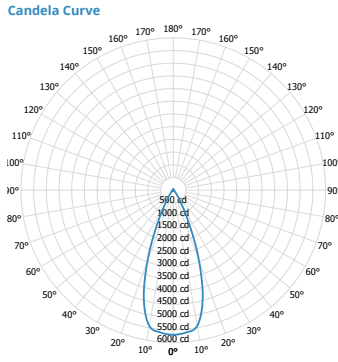

Mounting Height AFF	FC at Center on Floor	Beam Diameter
8.0 ft	89 fc	6.0 ft
10.0 ft	57 fc	7.4 ft
12.0 ft	40 fc	8.9 ft
14.0 ft	29 fc	10.4 ft
16.0 ft	22 fc	11.9 ft
20.0 ft	14 fc	14.9 ft
24.0 ft	10 fc	17.9 ft
30.0 ft	6 fc	22.3 ft

Candela Table	0.00°
0.00°	5699
5.00°	5633
10.00°	5431
15.00°	4476
20.00°	2967
30.00°	698
40.00°	185
50.00°	74
60.00°	46
70.00°	27
80.00°	19
90.00°	12

Zonal Lumen Summary	Zone	Lumens	% Luminaire
0° - 30°	2461	82%	
0° - 40°	2698	90%	
0° - 60°	2839	95%	
60° - 90°	77	3%	
0° - 20°	1733	58%	
20° - 50°	1055	35%	
50° - 70°	88	3%	
70° - 90°	40	1%	
0° - 90°	2916	97%	
90° - 180°	82	3%	
Total	2999	100%	

Spacing Criterion	Height	Spacing	Light Level*
8 ft	5.4 ft	~ 89 fc	
10 ft	6.7 ft	~ 57 fc	
12 ft	8.0 ft	~ 40 fc	
8 ft	4.0 ft	~ 158 fc	
10 ft	5.0 ft	~ 101 fc	
12 ft	6.0 ft	~ 70 fc	
8 ft	2.7 ft	~ 356 fc	
10 ft	3.4 ft	~ 228 fc	
12 ft	4.0 ft	~ 158 fc	

* approximate direct light level at floor based on spacing criterion overlap

MULTIPLIER

CRI	Multiplier	Kelvin	Multiplier
80	1	2700K	0.955
90	0.8	3000K	0.965
		3500K	0.975
		4000K	1



4"X12" Luxify™ Cylinder

Flush Lensed LED 700-3000 Lumens

Dimensional Data

VC - CEILING/SURFACE MOUNT

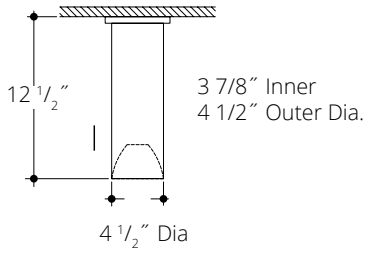

VW - WALL MOUNT

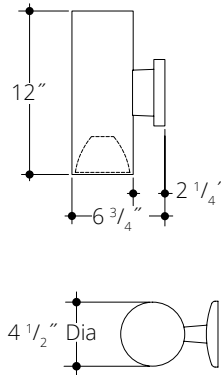

VV - PENDANT MOUNT

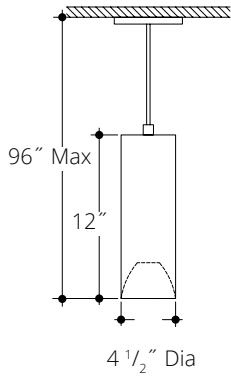

VC WITH CCK-"XX" - CORD & CABLE MOUNT

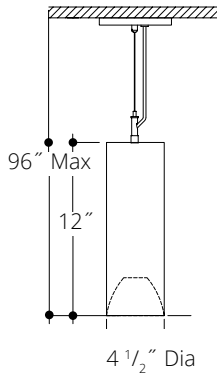

VC WITH CK-"XX" - CORD MOUNT

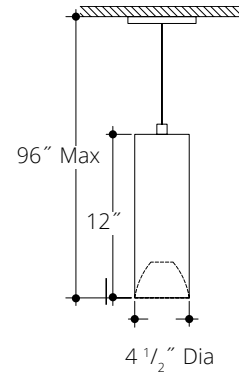

Housing Finishes



WHT
WHITE MATTE

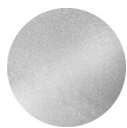

CS
SILVER



BLK
BLACK MATTE



BZ
BRONZE

4"X12" Luxify™ Cylinder

Flush Lensed LED 700-3000 Lumens

Canopy Information

VP - With Standard Driver up to 2000 Lumens

Pendant Mount, rigid stem, swivel canopy, up to 45° slope ceiling

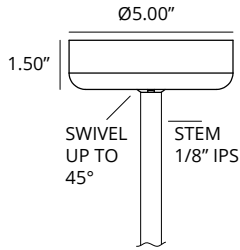

Driver Compatibility

For 700 - 2000 Lumens
SDM (standard)
ZDM

VP - With Optional Drivers and Standard driver above 2000 Lumens

Canopy for larger driver options. Driver located in canopy.

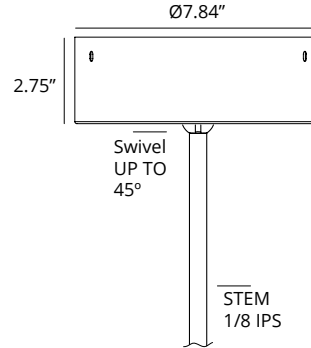

Driver Compatibility

For 700 - 3000 Lumens
TDM
DTD
DMX
DL-2
DL-3
LDE1
PEQ0

For 3000 Lumens
SDM
ZDM

CCK - With Standard Driver up to 2000 Lumens

Cord & Cable Mount, fixed canopy (standard)

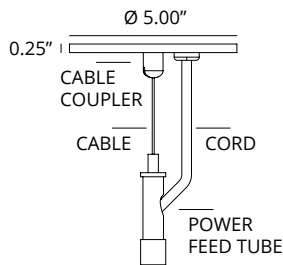

Driver Compatibility

For 700 - 2000 Lumens
SDM (standard)
ZDM

CCK - With Optional Drivers and Standard driver above 2000 Lumens

Cord & Cable Mount, fixed canopy (standard)

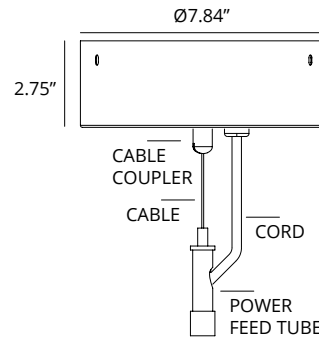

Driver Compatibility

For 700 - 3000 Lumens
TDM
DTD
DMX
DL-2
DL-3
LDE1
PEQ0

For 3000 Lumens
SDM
ZDM

Mounting Options Notes

P-XX" - 1/8" IP x12" rigid stem with swivel canopy to accommodate sloped ceilings up to 45°. Standard Pendant lengths (stem): 12", 24", and 36". If a different length is desired, please specify in 12" increments and add a field cut kit to the order (CH272TK).
CK-XX" 5 conductor cord to support 0-10V dimming (standard). Other lengths available.
Optional Drivers - Requires larger canopy, see canopy details for more information

WALL MOUNT EXTENSION and Standard driver above 2000 Lumens

Wall Mount Extension for larger optional drivers

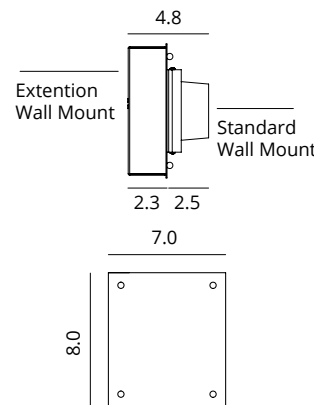

Driver Compatibility

For 700 - 3000 Lumens
TDM
DTD
DL-2
DL-3
LDE1
PEQ0

For 3000 Lumens
SDM
ZDM