

Architectural Cylinders

Job Name _____

Type _____

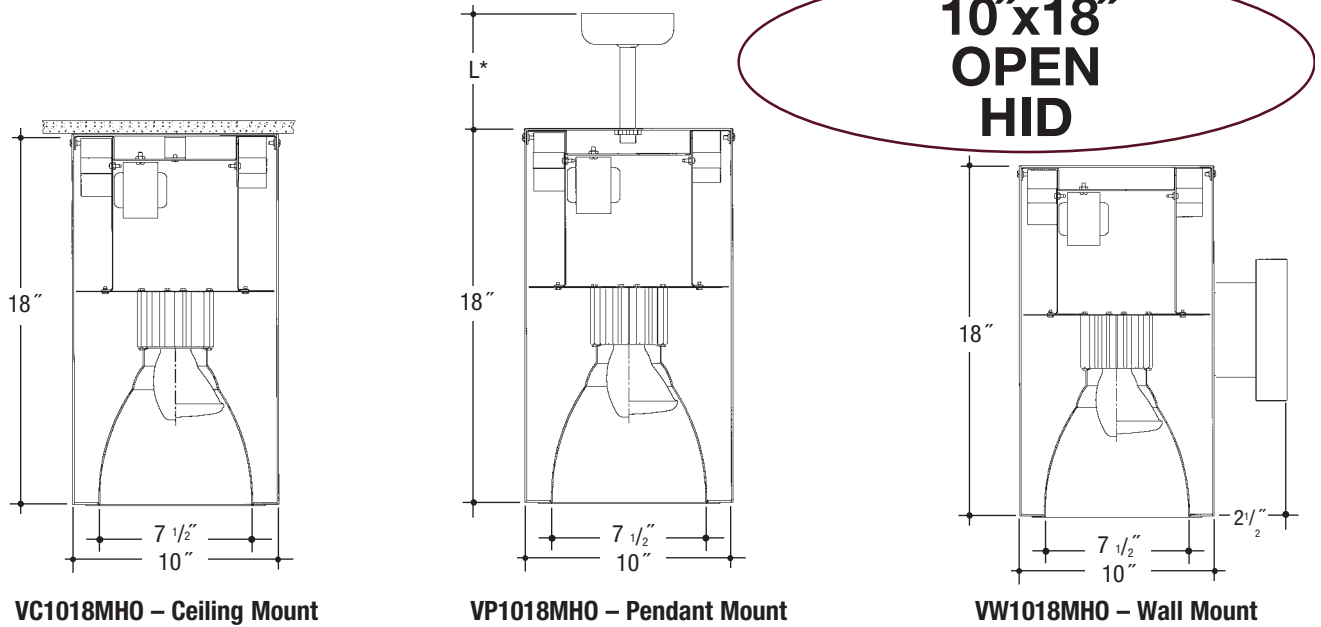

Cylinder – HID (ED17; PAR38; PAR30; PAR20 Open Rated* Lamp). *Note: 'Open Fixture Rated' lamp must be used. Specular Clear "Alzak" Reflector

Catalog Number	Wattage	Ballast	Voltage	Finish	Reflector	Options
VC1018MHO	150W MAX. PAR38, ED17	E	1	WHT	SCL	QR
VP1018MHO	100W PAR38, ED17		2	BLK	SGC	QS
VW1018MHO	70W PAR30, ED17		4	BZ	WHT	
	50W PAR30, ED17			CS		

For PAR Lamp – Replace VC1018MHO with VC1018MHOP

HPS – Replace MH with HPS – VC1018HPSO

HPS – High Pressure Sodium available up to 150 Watt.

Specifications

Housing – .064" thick spun aluminum cylinder. Polyester powdercoat exterior finish with factory standard finishes of White (WHT), Black (BLK), Bronze (BZ), Camero Silver (CS).

Socket – Open Rated, Pulse Rated, 4KV, medium base porcelain with nickel plated brass screw shell. *UL Listed.*

Ballast – 50/60Hz Multi-tap electronic ballast to operate from range of 120V to 277V +/- 10%. Minimum starting temperature of -30°C/-20°F. *UL Listed* component.

Reflector – Heavy gauge hand spun aluminum reflector with a specular "Alzak" low iridescent finish.

Pendant – Pendant mount accepts slope ceilings with a 45° swivel adjustment. L* – Factory Standard stem length is 12'.

Wall Bracket – Cast Aluminum Construction.

Voltage

1	120 Volt
2	277 Volt
4	208 Volt

Ballast

E Electronic

Reflector Options ▲

SCL	Specular Clear "Alzak" with White Flange
SGC	Soft Glow Clear "Alzak" with White Flange
WHT	White Reflector with White Flange

Options ▲

QR	Quartz Restrike
QS	Quartz Socket

Features

Manufactured and Listed to UL 1598, ETL and CSA standards.
 Suitable for Damp Locations
 Wet location under covered ceiling
 Suitable for Wet Locations



▲ See Options and Finishes pages for a list of additional finishes and equipment.

Vantage reserves the right to change components, finishes or design details in any manner which does not alter the installed appearance or reduce performance and intended function.

76 Community Avenue Plainfield, CT 06374
 voice (860) 564.4512 fax (860) 564.4854
 www.vantageitg.com

11/11



VANTAGE

Photometric Information

Product Number: VC1018MHO70H/SCL
Cylinder: 10"x18", Vertical Mount Metal Halide
Reflector: 8" Vertical Clear "Alzak" Reflector
LTL Test Number: 07000
Lamp(s) Source: (1) 70W ED17 coated Metal Halide rated at 5000 lumens
Total Luminaire Efficiency: 63.2%
CIE Type: Direct
Luminaire Spacing Criterion: 0.9
Luminous Diameter: 7.500

Product Number: VC1018MHO100H/SCL
Cylinder: 10"x18", Vertical Mount Metal Halide
Reflector: 8" Vertical Clear "Alzak" Reflector
LTL Test Number: 07001
Lamp(s) Source: (1) 100W ED17 coated Metal Halide rated at 7800 lumens
Total Luminaire Efficiency: 64.6%
CIE Type: Direct
Luminaire Spacing Criterion: 1.0
Luminous Diameter: 7.500

Zonal Lumen Summary

ZONE	LUMENS	%LAMP	%FIXTURE
0- 30	2115	42.3	66.9
0- 40	2839	56.8	89.8
0- 60	3151	63.0	99.7
0- 90	3161	63.2	100.0
90-180	0	0.0	0.0
0-180	3161	63.2	100.0

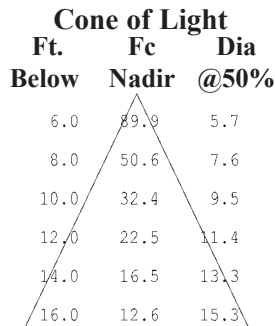

Coefficients of Utilization

RC	80			70			50			30			10			0		
RW	70	50	30	10	70	50	30	10	50	30	10	50	30	10	50	30	10	0
0	75	75	75	75	74	74	74	74	70	70	70	67	67	67	65	65	65	63
1	72	71	69	68	71	69	68	67	67	66	65	64	64	63	62	62	61	60
2	69	67	64	62	68	65	63	62	63	62	60	62	60	59	60	59	58	57
3	66	63	60	58	65	62	59	57	60	58	57	59	57	56	57	56	55	54
4	64	59	56	54	62	59	56	54	57	55	53	56	54	52	55	53	52	51
5	61	56	53	50	60	55	52	50	54	52	50	53	51	49	52	50	49	48
6	58	53	50	47	57	53	49	47	52	49	47	51	48	47	50	48	46	45
7	55	50	47	44	54	50	46	44	49	46	44	48	45	44	47	45	43	43
8	53	47	44	41	52	47	44	41	46	43	41	46	43	41	45	43	41	40
9	50	44	41	39	49	44	41	38	43	40	38	43	40	38	42	40	38	37
10	48	42	38	36	47	42	38	36	41	38	36	41	38	36	40	38	36	35

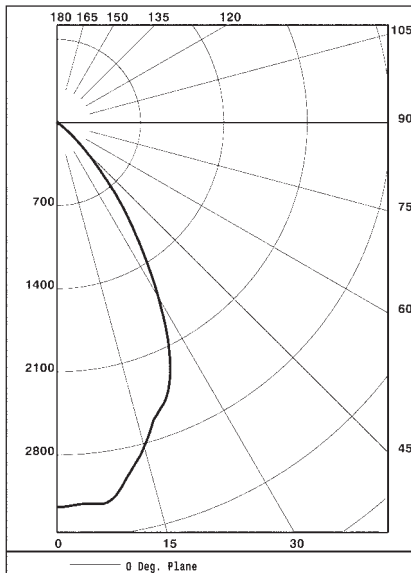

Zonal Lumen Summary

ZONE	LUMENS	%LAMP	%FIXTURE
0- 30	3246	41.6	64.4
0- 40	4470	57.3	88.7
0- 60	5033	64.5	99.9
0- 90	5040	64.6	100.0
90-180	0	0.0	0.0
0-180	5040	64.6	100.0

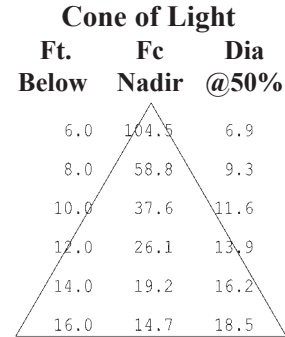

Coefficients of Utilization

RC	80			70			50			30			10			0		
RW	70	50	30	10	70	50	30	10	50	30	10	50	30	10	50	30	10	0
0	77	77	77	77	75	75	75	75	72	72	72	69	69	69	66	66	66	65
1	74	72	71	69	72	71	69	68	68	67	66	66	65	64	63	63	62	61
2	71	68	65	63	69	67	65	63	65	63	61	63	61	60	61	60	59	58
3	68	64	61	59	66	63	60	58	61	59	57	60	58	56	58	57	56	55
4	65	60	57	55	63	59	56	54	58	56	54	57	55	53	56	54	52	51
5	61	57	53	51	60	56	53	50	55	52	50	54	51	49	53	51	49	48
6	59	53	50	47	58	53	50	47	52	49	47	51	48	47	50	48	46	45
7	56	50	46	44	55	50	46	44	49	46	44	48	45	43	47	45	43	42
8	53	47	43	41	52	47	43	41	46	43	41	45	43	40	45	42	40	39
9	50	44	40	38	49	44	40	38	43	40	38	43	40	38	42	39	37	37
10	47	41	38	35	47	41	38	35	41	37	35	40	37	35	40	37	35	34

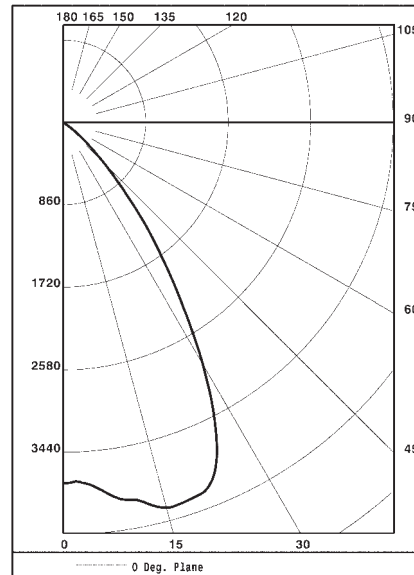

VANTAGE

06/07

Photometric Information

Product Number: VC1018MHO100H/SCL
Cylinder: 10"x18", Vertical Mount Metal Halide
Reflector: 8" Vertical Clear "Alzak" Reflector
LTL Test Number: 06867
Lamp(s) Source: (1) 100W PAR38/U/FL35 Metal Halide rated at 5800 lumens
Total Luminaire Efficiency: 97.4%
CIE Type: Direct
Luminaire Spacing Criterion: 0.7
Luminous Diameter: 7.500

Zonal Lumen Summary

ZONE	LUMENS	%LAMP	%FIXTURE
0- 30	5080	87.6	89.9
0- 40	5556	95.8	98.3
0- 60	5649	97.4	100.0
0- 90	5649	97.4	100.0
90-180	0	0.0	0.0
0-180	5649	97.4	100.0

Cone of Light

Ft. Below	Fc Nadir	Dia @50%
6.0	252.8	4.7
8.0	147.8	6.3
10.0	94.6	7.9
12.0	65.7	9.5
14.0	48.3	11.0
16.0	37.0	12.6

Coefficients of Utilization

RC	80	70	50	30	10	0
RW	70 50 30 10	70 50 30 10	50 30 10	50 30 10	50 30 10	50 30 10 0
0	116116116116	113113113113	108108108	104104104	99 99 99	97
1	112110108107	110108107105	104103102	101100 99	97 97 96	94
2	109105103100	107104101 99	101 99 97	98 96 95	95 94 93	92
3	106101 98 96	104100 97 95	98 95 93	96 94 92	94 92 91	89
4	103 98 94 91	101 97 93 91	95 92 90	93 91 89	91 89 88	87
5	99 94 90 87	98 93 90 87	92 89 86	90 88 86	89 87 85	84
6	97 91 87 84	96 90 87 84	89 86 84	88 85 83	87 85 83	82
7	94 88 84 81	93 87 84 81	86 83 81	85 82 80	84 82 80	79
8	91 85 81 78	90 84 81 78	84 80 78	83 80 78	82 79 77	76
9	88 82 78 75	87 82 78 75	81 77 75	80 77 75	79 77 75	74
10	86 79 75 73	85 79 75 73	78 75 73	78 75 72	77 74 72	71

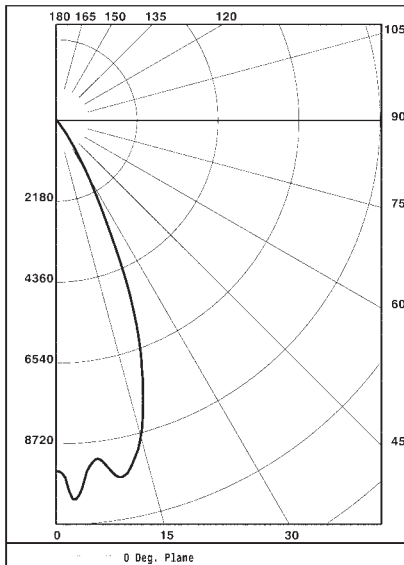

Product Number: VC1018MHO150H/SCL
Cylinder: 10"x18", Vertical Mount Metal Halide
Reflector: 8" Vertical Clear "Alzak" Reflector
LTL Test Number: 06998
Lamp(s) Source: (1) 150W ED17 coated Metal Halide rated at 11,500 lumens
Total Luminaire Efficiency: 63.4%
CIE Type: Direct
Luminaire Spacing Criterion: 1.0
Luminous Diameter: 7.500

Zonal Lumen Summary

ZONE	LUMENS	%LAMP	%FIXTURE
0- 30	4795	41.7	65.7
0- 40	6624	57.6	90.8
0- 60	7295	63.4	100.0
0- 90	7295	63.4	100.0
90-180	0	0.0	0.0
0-180	7295	63.4	100.0

Cone of Light

Ft. Below	Fc Nadir	Dia @50%
6.0	157.3	7.1
8.0	88.5	9.4
10.0	56.6	11.8
12.0	39.3	14.1
14.0	28.9	16.5
16.0	22.1	18.8

Coefficients of Utilization

RC	80	70	50	30	10	0
RW	70 50 30 10	70 50 30 10	50 30 10	50 30 10	50 30 10	50 30 10 0
0	76 76 76 76	74 74 74 74	70 70 70	67 67 67	65 65 65	63
1	72 71 69 68	71 69 68 67	67 66 65	65 64 63	62 62 61	60
2	69 67 64 63	68 66 64 62	64 62 61	62 60 59	60 59 58	57
3	66 63 60 58	65 62 59 57	60 58 57	59 57 56	58 56 55	54
4	64 59 56 54	62 59 56 54	57 55 53	56 54 52	55 53 52	51
5	61 56 53 50	60 55 52 50	54 52 49	53 51 49	52 50 49	48
6	58 53 49 47	57 52 49 47	51 49 47	51 48 46	50 48 46	45
7	55 50 46 44	54 49 46 44	48 45 43	48 45 43	47 45 43	42
8	52 47 43 41	52 46 43 41	46 43 40	45 42 40	44 42 40	39
9	49 44 40 38	49 43 40 38	43 40 38	42 39 37	42 39 37	37
10	47 41 38 35	46 41 37 35	40 37 35	40 37 35	39 37 35	34

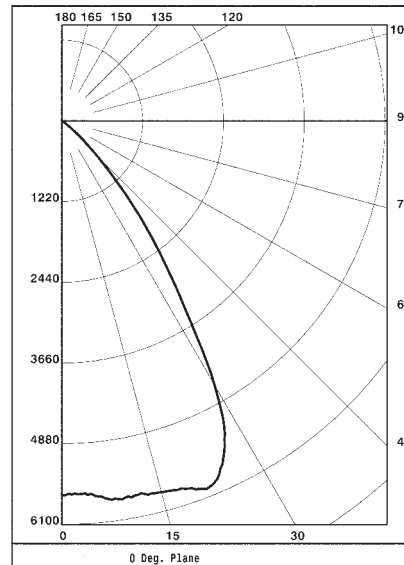

VANTAGE