

Architectural Cylinders

Job Name _____

Type _____

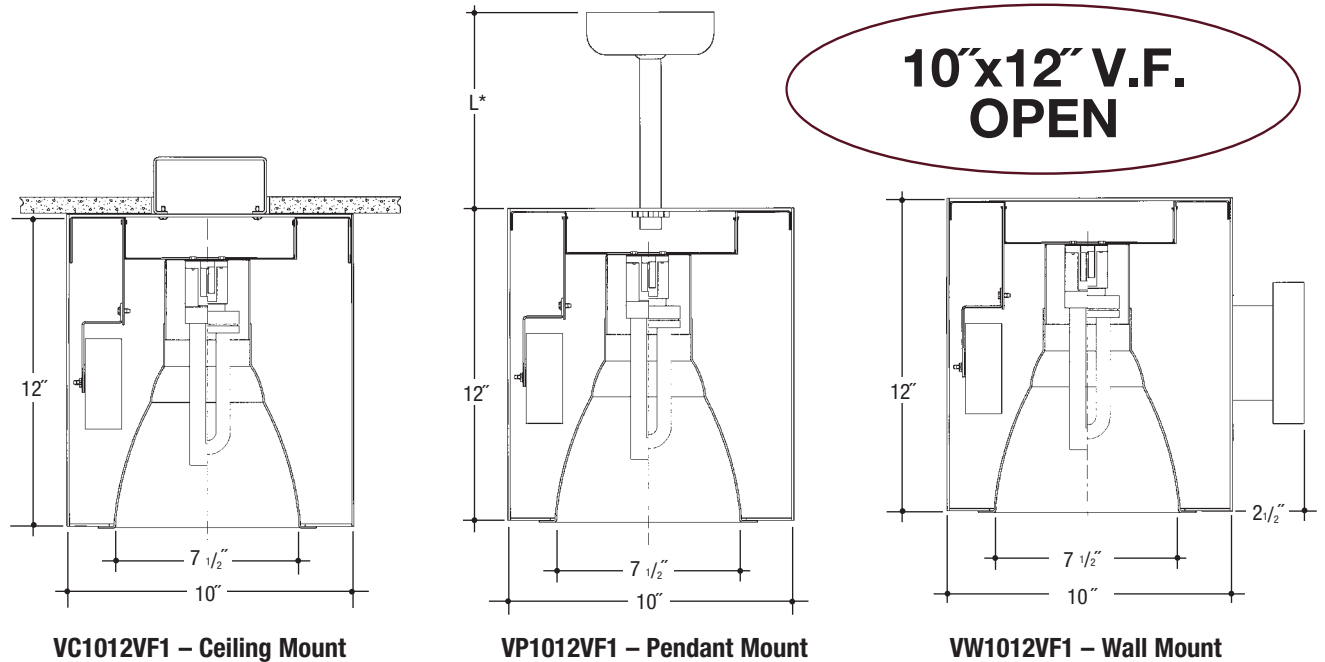

Cylinder – Vertical Fluorescent 1-Lamp (Compact Fluorescent Quad or Triple Tube) Clear “Alzak” Reflector

Catalog Number

	Wattage	Ballast	Voltage	Finish	Reflector	Options
VC1012VF1	42W MAX. PLT	E	1	WHT	SCL	REM
VP1012VF1	32W PLT	DA	2	BLK	SGC	WL
VW1012VF1	26W DTT, PLT		4	BZ		
	18W DTT, PLT			CS		
	13W DTT					

Electronic Multi-Tap Ballast 120 Thru 277V Factory Standard

Specifications

Housing – .064” thick spun aluminum cylinder. Polyester powdercoat exterior finish with factory standard finishes White (WHT), Black (BLK), Bronze (BZ), Camero Silver (CS).

Socket – Thermo-plastic and positive locking. *UL Listed*.

Ballast – Electronic ballast, Class P, 50/60 HZ-120/277, Programmed Start, thermally protected, 98% Power Factor, 1.00 Ballast Factor, <10% THD, Class A sound rated. Minimum starting temperature -18°C/0°F. *UL Listed* component.

Reflector – Heavy gauge hand spun aluminum reflector with a specular “Alzak” low iridescent finish and rolled polished flange.

Pendant – Pendant mount accepts slope ceilings with a 45° swivel adjustment.

L* – Factory Standard stem length is 12’.

Wall Bracket – Cast Aluminum Construction.

Voltage

1	120 Volt
2	277 Volt
4	208 Volt

Ballast

E	Electronic	(4 Pin Lamp)
DA	Advance Mark X Dimming	(4 Pin Lamp)
*	13 Watt Advance Mark VII Only	(4 Pin Lamp)

Reflector Options ▲

SCL	Specular Clear “Alzak” with White Flange
SGC	Soft Glow Clear “Alzak” with White Flange

Options ▲

REM	Remote Emergency Battery
WL	Suitable for Wet Locations

Features

Manufactured and Listed to UL 1598, ETL and CSA standards. Suitable for Damp Locations Wet location under covered ceiling Suitable for Wet Locations



▲ See Options and Finishes pages for a list of additional finishes and equipment.

Vantage reserves the right to change components, finishes or design details in any manner which does not alter the installed appearance or reduce performance and intended function.

76 Community Avenue Plainfield, CT 06374
 voice (860)564.4512 fax (860)564.4854
 www.vantageitg.com

11/11



VANTAGE

Photometric Information

Product Number: VC1012VF113E/SCL
Cylinder: 10" x 12" Vertical Mount Fluorescent
Reflector: 8" Vertical Clear "Alzak" Reflector
LTL Test Number: 06133
Lamp(s) Source: (1) 13W DTT 4 pin lamp rated at 900 lumens
Total Luminaire Efficiency: 59.5%
CIE Type: Direct
Luminaire Spacing Criterion: 1.0
Luminous Diameter: 7.500

Product Number: VC1012VF126E/SCL
Cylinder: 10" x 12" Vertical Mount Fluorescent
Reflector: 8" Vertical Clear "Alzak" Reflector
LTL Test Number: 06134
Lamp(s) Source: (1) 26W DTT 4 pin lamp rated at 1800 lumens
Total Luminaire Efficiency: 48.8%
CIE Type: Direct
Luminaire Spacing Criterion: 0.6
Luminous Diameter: 7.500

Zonal Lumen Summary

ZONE	LUMENS	%LAMP	%FIXTURE
0- 30	316	35.1	59.0
0- 40	460	51.1	85.8
0- 60	536	59.5	100.0
0- 90	536	59.5	100.0
90-180	0	0.0	0.0
0-180	536	59.5	100.0

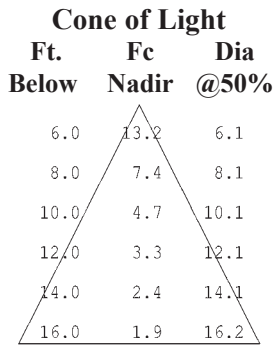

Coefficients of Utilization

RC	80				70				50				30				10				0
RW	70	50	30	10	70	50	30	10	50	30	10	50	30	10	50	30	10	50	30	10	0
0	71	71	71	71	69	69	69	69	66	66	66	63	63	63	61	61	61	61	61	61	0
1	68	66	65	63	66	65	63	62	62	61	60	60	59	58	58	57	57	57	56	56	56
2	64	61	59	57	63	60	58	56	58	57	55	57	55	54	55	54	53	52	52	52	52
3	61	57	54	52	60	56	53	51	55	52	50	53	51	50	52	50	49	48	48	48	48
4	58	53	50	47	56	52	49	47	51	48	46	50	48	46	49	47	45	44	44	44	44
5	54	49	46	43	53	49	45	43	48	45	42	47	44	42	46	43	42	41	41	41	41
6	51	46	42	40	51	46	42	40	45	42	39	44	41	39	43	41	39	38	38	38	38
7	49	43	39	36	48	42	39	36	42	38	36	41	38	36	40	38	36	35	35	35	35
8	46	39	36	33	45	39	36	33	38	35	33	38	35	33	37	35	33	32	32	32	32
9	43	36	33	30	42	36	32	30	35	32	30	35	32	30	34	32	30	29	29	29	29
10	40	34	30	27	39	33	30	27	33	29	27	32	29	27	32	29	27	26	26	26	26

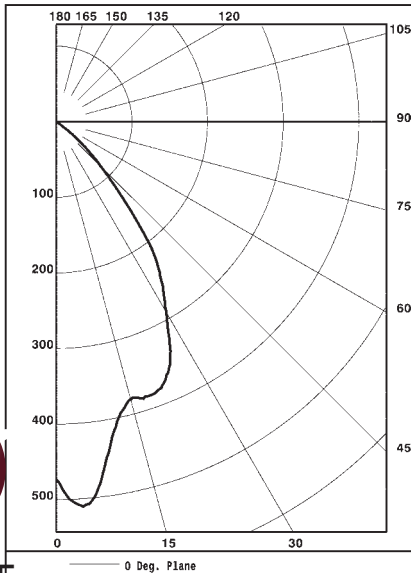

Zonal Lumen Summary

ZONE	LUMENS	%LAMP	%FIXTURE
0- 30	602	33.4	68.6
0- 40	797	44.3	90.8
0- 60	878	48.8	100.0
0- 90	878	48.8	100.0
90-180	0	0.0	0.0
0-180	878	48.8	100.0

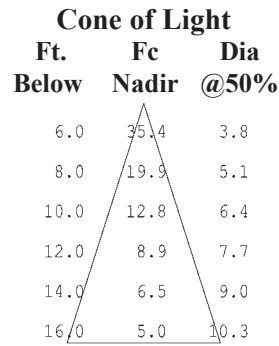

Coefficients of Utilization

RC	80				70				50				30				10				0
RW	70	50	30	10	70	50	30	10	50	30	10	50	30	10	50	30	10	50	30	10	0
0	58	58	58	58	57	57	57	57	54	54	54	52	52	52	50	50	50	49	49	49	49
1	56	54	53	52	54	53	52	51	51	51	50	49	49	48	48	47	47	46	46	46	46
2	53	51	49	47	52	50	48	47	48	47	46	47	46	45	46	45	44	43	43	43	43
3	51	48	45	43	50	47	45	43	46	44	42	44	43	42	43	42	41	40	40	40	40
4	48	45	42	40	47	44	42	40	43	41	39	42	40	39	41	40	38	38	38	38	38
5	46	42	39	37	45	41	39	37	40	38	36	40	38	36	39	37	36	35	35	35	35
6	44	39	37	35	43	39	36	34	38	36	34	38	36	34	37	35	34	33	33	33	33
7	41	37	34	32	41	37	34	32	36	34	32	35	33	32	35	33	32	31	31	31	31
8	39	35	32	30	39	34	32	30	34	31	30	33	31	29	33	31	29	29	29	29	29
9	37	32	29	27	36	32	29	27	32	29	27	31	29	27	31	29	27	26	26	26	26
10	35	30	27	25	34	30	27	25	29	27	25	29	27	25	29	27	25	24	24	24	24

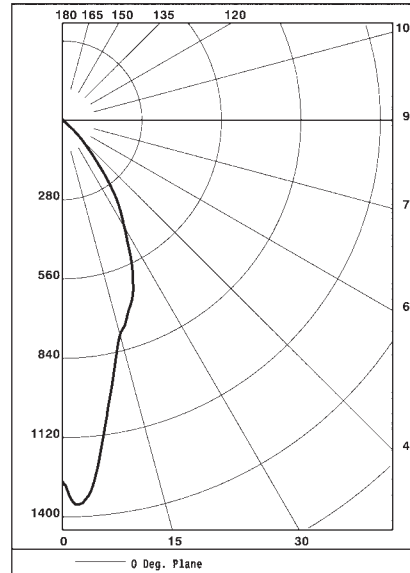

Photometric Information

Product Number: VC1012VF126E/SCL
Cylinder: 10" x 12" Vertical Mount Fluorescent
Reflector: 8" Vertical Clear "Alzak" Reflector
LTL Test Number: 06144
Lamp(s) Source: (1) 26W PLT 4 pin lamp rated at 1800 lumens
Total Luminaire Efficiency: 58.2%
CIE Type: Direct
Luminaire Spacing Criterion: 1.2/1.2
Luminous Diameter: 7.500

Product Number: VC1012VF132E/SCL
Cylinder: 10" x 12" Vertical Mount Fluorescent
Reflector: 8" Vertical Clear "Alzak" Reflector
LTL Test Number: 06241
Lamp(s) Source: (1) 32W PLT 4 pin lamp rated at 2400 lumens
Total Luminaire Efficiency: 59.5%
CIE Type: Direct
Luminaire Spacing Criterion: 1.3/1.3
Luminous Diameter: 7.500

Zonal Lumen Summary

ZONE	LUMENS	%LAMP	%FIXTURE
0- 30	632	35.1	60.3
0- 40	920	51.1	87.8
0- 60	1048	58.2	100.0
0- 90	1048	58.2	100.0
90-180	0	0.0	0.0
0-180	1048	58.2	100.0

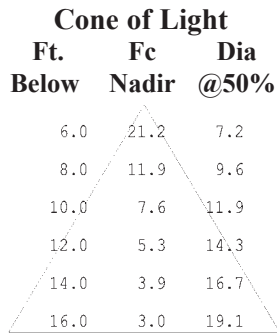

Zonal Lumen Summary

ZONE	LUMENS	%LAMP	%FIXTURE
0- 30	734	30.6	51.4
0- 40	1136	47.3	79.6
0- 60	1427	59.5	100.0
0- 90	1427	59.5	100.0
90-180	0	0.0	0.0
0-180	1427	59.5	100.0

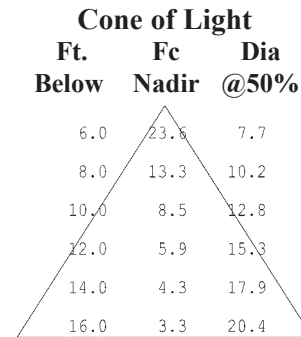

Coefficients of Utilization

RC	80				70				50				30				10				0
RW	70	50	30	10	70	50	30	10	50	30	10	50	30	10	50	30	10	50	30	10	0
0	69	69	69	69	68	68	68	68	65	65	65	62	62	62	59	59	59	58	58	58	58
1	66	65	63	62	65	63	62	61	61	60	59	59	58	57	57	56	56	55	55	55	55
2	63	60	58	56	62	59	57	55	57	55	54	55	54	53	54	53	52	51	51	51	51
3	60	56	53	51	58	55	52	50	54	51	49	52	50	49	51	49	48	47	47	47	47
4	56	52	49	46	55	51	48	46	50	47	45	49	47	45	48	46	44	43	43	43	43
5	53	48	45	42	52	48	44	42	47	44	42	46	43	41	45	43	41	40	40	40	40
6	50	45	41	39	50	45	41	39	44	41	39	43	40	38	42	40	38	37	37	37	37
7	48	42	38	36	47	42	38	36	41	38	35	40	37	35	39	37	35	34	34	34	34
8	45	39	35	33	44	38	35	32	38	35	32	37	34	32	37	34	32	31	31	31	31
9	42	36	32	29	41	35	32	29	35	31	29	34	31	29	34	31	29	28	28	28	28
10	39	33	29	27	38	33	29	27	32	29	27	32	29	27	31	28	26	26	26	26	26

Coefficients of Utilization

RC	80				70				50				30				10				0
RW	70	50	30	10	70	50	30	10	50	30	10	50	30	10	50	30	10	50	30	10	0
0	71	71	71	71	69	69	69	69	66	66	66	63	63	63	61	61	61	59	59	59	59
1	67	66	64	63	66	64	63	62	62	61	60	60	59	58	58	57	56	55	55	55	55
2	64	61	58	56	62	60	57	55	58	56	54	56	54	53	54	53	52	51	51	51	51
3	60	56	53	50	59	55	52	50	54	51	49	52	50	48	51	49	48	47	47	47	47
4	57	52	48	45	55	51	48	45	50	47	45	48	46	44	47	45	44	43	43	43	43
5	53	48	44	41	52	47	43	41	46	43	40	45	42	40	44	42	40	39	39	39	39
6	50	44	40	37	49	44	40	37	43	39	37	42	39	37	41	38	36	36	36	36	36
7	47	41	37	34	46	40	36	34	39	36	34	39	36	33	38	35	33	32	32	32	32
8	44	37	33	30	43	37	33	30	36	33	30	35	32	30	35	32	30	29	29	29	29
9	40	34	30	27	40	34	30	27	33	29	27	32	29	27	32	29	27	26	26	26	26
10	38	31	27	24	37	31	27	24	30	27	24	30	26	24	29	26	24	23	23	23	23

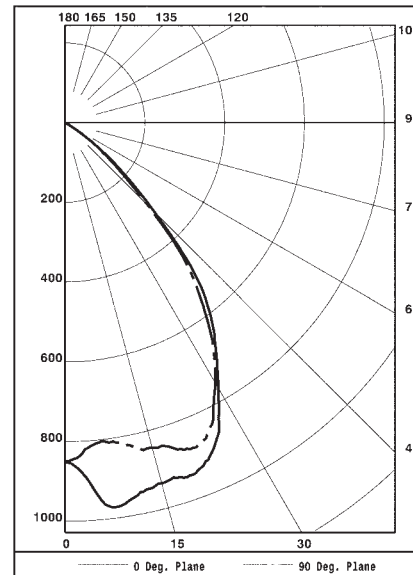
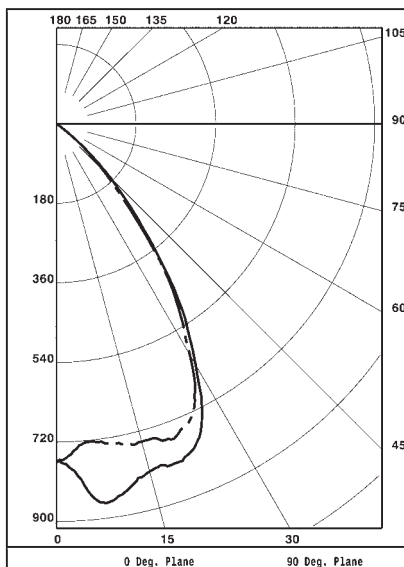

VANTAGE

Photometric Information

Product Number: VC1012VF142E/SCL
Cylinder: 10" x 12" Vertical Mount Fluorescent
Reflector: 8" Vertical Clear "Alzak" Reflector
LTL Test Number: 06283
Lamp(s) Source: (1) 42W PLT 4 pin lamp rated at 3200 lumens
Total Luminaire Efficiency: 43.4%
CIE Type: Direct
Luminaire Spacing Criterion: 1.0/1.0
Luminous Diameter: 7.500

Zonal Lumen Summary

ZONE	LUMENS	%LAMP	%FIXTURE
0- 30	932	29.1	67.1
0- 40	1261	39.4	90.8
0- 60	1389	43.4	100.0
0- 90	1389	43.4	100.0
90-180	0	0.0	0.0
0-180	1389	43.4	100.0

Cone of Light

Ft. Below	Fc Nadir	Dia @50%
6.0	35.6	6.1
8.0	20.0	8.2
10.0	12.8	10.2
12.0	8.9	12.3
14.0	6.5	14.3
16.0	5.0	16.3

Coefficients of Utilization

RC	80				70				50				30				10				0
RW	70	50	30	10	70	50	30	10	50	30	10	50	30	10	50	30	10	50	30	10	0
0	52	52	52	52	50	50	50	50	48	48	48	46	46	46	44	44	44	44	44	43	0
1	49	48	47	46	48	47	46	46	46	45	44	44	43	43	43	42	42	42	42	41	0
2	47	45	43	42	46	44	43	42	43	42	41	42	41	40	40	40	39	39	38	38	0
3	45	42	40	38	44	42	40	38	40	39	38	39	38	37	38	37	36	36	36	36	0
4	43	39	37	35	42	39	37	35	38	36	35	37	36	34	36	35	34	33	33	33	0
5	40	37	34	32	40	36	34	32	36	34	32	35	33	32	34	33	31	31	31	31	0
6	38	35	32	30	38	34	32	30	34	32	30	33	31	30	32	31	30	29	29	29	0
7	36	32	30	28	36	32	30	28	32	29	28	31	29	28	31	29	28	27	27	27	0
8	34	30	28	26	34	30	27	26	29	27	26	29	27	26	29	27	25	25	25	25	0
9	32	28	25	24	32	28	25	24	27	25	23	27	25	23	27	25	23	23	23	23	0
10	30	26	23	22	30	26	23	22	25	23	22	25	23	22	25	23	21	21	21	21	0

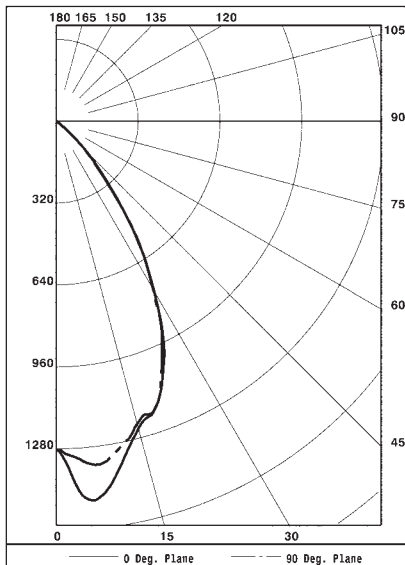

VANTAGE

08/07

76 Community Avenue Plainfield, CT 06374 voice (860)564.4512 fax (860)564.4854 www.vantageltg.com