

Architectural Grade

Job Name _____

Type _____

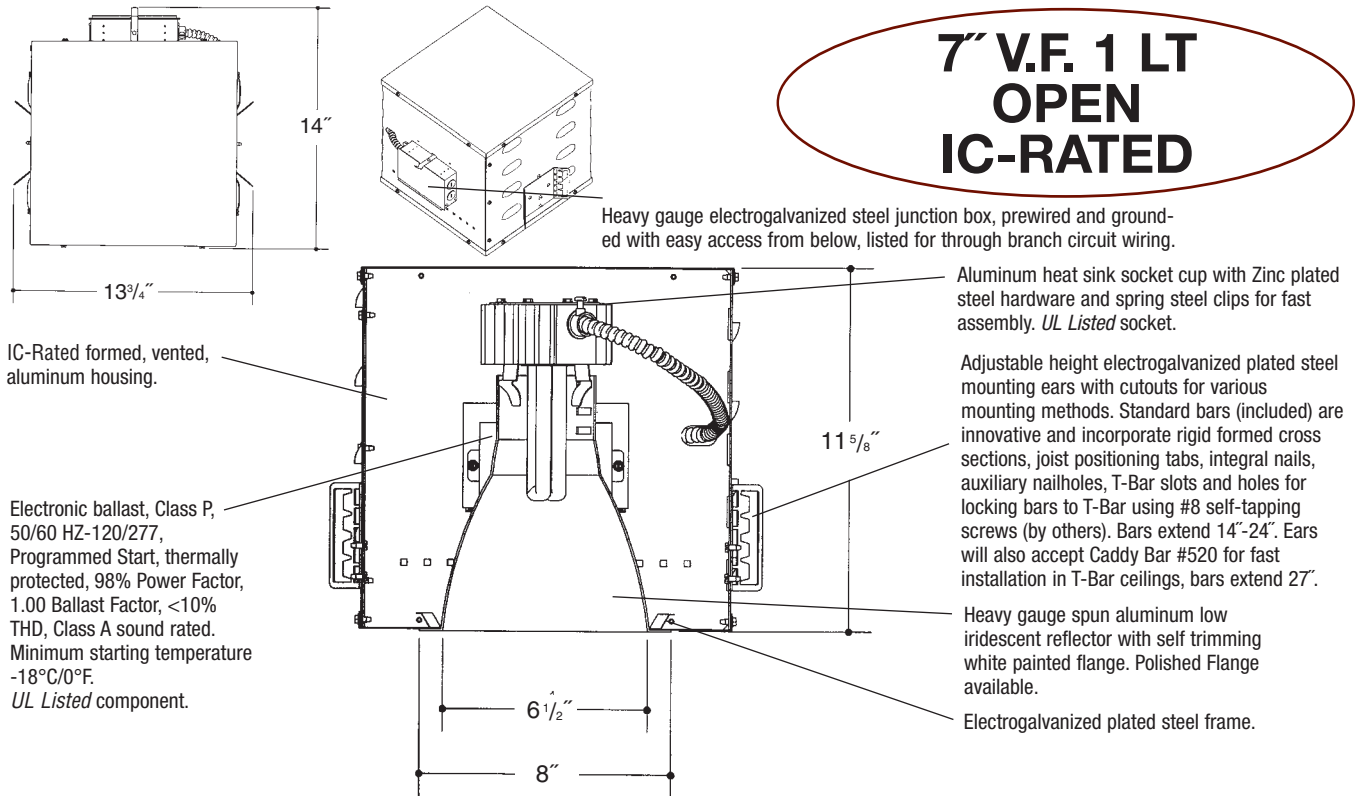

**7" V.F. 1 LT
OPEN
IC-RATED**

Rough in Kit – 7" Vertical Fluorescent 1-Lamp IC-Rated (Compact Fluorescent Twin, Quad or Triple Tube)

Catalog Number **AIC7VF1**

AIC7VF1	Wattage	Ballast	Voltage	Options
	42W MAX. PLT	E	1	F
	32W PLT	DA	2	PR
	26W DTT, PLT		3	EMI
	18W DTT, PLT		4	
	13"W TT, DTT			

Ballast	E	Electronic	(4 Pin Lamp)
	DA	Dimming - Advance Mark X	(4 Pin Lamp)
	*	13W Advance Mark VII Only	
Voltage	1	120 Volts	
	2	277 Volts	
	3	347 Volts (Electronic Ballast Only)	
	4	208 Volts (Electronic Ballast Only)	
Options ▲	F	Fused	
	PR	Plaster Ring	
	EMI	Internal Mounted Emergency Test Switch	

2-Lamp Not Available in Triple Tube

2-Lamp – Replace AIC7VF1 with AIC7VF2

Electronic Multi-Tap Ballast 120V Thru 277V Factory Standard

Finishing Kit – 7" Vertical Fluorescent Open Reflector^{###}

Catalog Number **7200**

7200	Finish	Options
	SCL	PF
	SGO	GSK
	WHT	

Finish (Factory Standard)

SCL	Specular Clear "Alzak" with White Flange
SGO	Specular Gold "Alzak" with White Flange
WHT	White Reflector with White Flange

Options ▲

PF	High Polished Flange
GSK	Neoprene Foam Single Gasketing

Consult Factory for Lensed Reflectors

Features

Manufactured and Listed to UL 1598, ETL and CSA standards.
Suitable for Damp Locations
Wet location under covered ceiling



▲ See Options and Finishes pages for a list of additional finishes and equipment.

Vantage reserves the right to change components, finishes or design details in any manner which does not alter the installed appearance or reduce performance and intended function.

Vantage

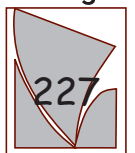

Luminaires

76 Community Avenue Plainfield, CT 06374

voice (860)564.4512 fax (860)564.4854

www.vantageitg.com

06/07

Photometric Information

Product Number: AIC7VF113E1/7200SCL
Frame In Kit: 7" Vertical Mount Fluorescent
Reflector: 7" Vertical Clear "Alzak" Reflector
LTL Test Number: 06129
Lamp(s) Source: (1) 13W DTT 4pin lamp rated at 900 lumens
Total Luminaire Efficiency: 55.2%
CIE Type: Direct
Luminaire Spacing Criterion: 1.0
Luminous Diameter: 6.500

Zonal Lumen Summary

ZONE	LUMENS	%LAMP	%FIXTURE
0- 30	290	32.2	58.3
0- 40	417	46.4	84.0
0- 60	497	55.2	100.0
0- 90	497	55.2	100.0
90-180	0	0.0	0.0
0-180	497	55.2	100.0

Cone of Light

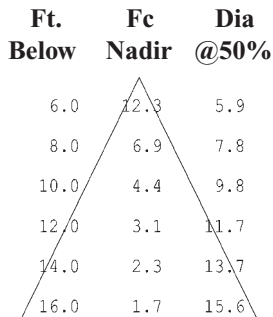

Coefficients of Utilization

RC	80				70				50				30				10				0											
RW	70	50	30	10	70	50	30	10	50	30	10	50	30	10	50	30	10	50	30	10	50	30	10	50	30	10	50	30	10	50	30	10
0	66	66	66	66	64	64	64	64	61	61	61	59	59	59	56	56	56	55														
1	63	61	60	59	61	60	59	58	58	57	56	56	55	54	54	53	53	52														
2	60	57	55	53	58	56	54	52	54	52	51	52	51	50	51	50	49	48														
3	56	53	50	48	55	52	50	47	51	48	47	49	47	46	48	47	45	44														
4	53	49	46	44	52	48	46	43	47	45	43	46	44	42	45	43	42	41														
5	50	46	42	40	49	45	42	40	44	41	39	43	41	39	42	40	39	38														
6	48	43	39	37	47	42	39	37	41	38	36	40	38	36	40	38	36	35														
7	45	40	36	34	44	39	36	34	38	36	33	38	35	33	37	35	33	32														
8	42	37	33	31	41	36	33	31	36	33	30	35	32	30	34	32	30	29														
9	39	34	30	28	39	33	30	28	33	30	28	32	29	27	32	29	27	27														
10	37	31	28	25	36	31	27	25	30	27	25	30	27	25	29	27	25	24														

Product Number: AIC7VF126E1/7200SCL
Frame In Kit: 7" Vertical Mount Fluorescent
Reflector: 7" Vertical Clear "Alzak" Reflector
LTL Test Number: 06130
Lamp(s) Source: (1) 26W DTT 4pin lamp rated at 1800 lumens
Total Luminaire Efficiency: 45.1%
CIE Type: Direct
Luminaire Spacing Criterion: 0.7
Luminous Diameter: 6.500

Zonal Lumen Summary

ZONE	LUMENS	%LAMP	%FIXTURE
0- 30	549	30.5	67.7
0- 40	727	40.4	89.6
0- 60	812	45.1	100.0
0- 90	812	45.1	100.0
90-180	0	0.0	0.0
0-180	812	45.1	100.0

Cone of Light

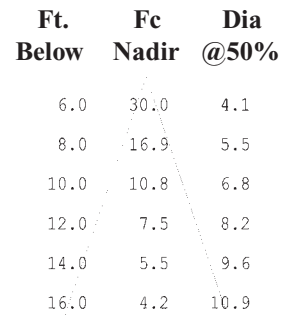

Coefficients of Utilization

RC	80				70				50				30				10				0											
RW	70	50	30	10	70	50	30	10	50	30	10	50	30	10	50	30	10	50	30	10	50	30	10	50	30	10	50	30	10	50	30	10
0	54	54	54	54	52	52	52	52	50	50	50	48	48	48	46	46	46	45														
1	51	50	49	48	50	49	48	47	47	47	46	46	45	45	44	44	43	43														
2	49	47	45	44	48	46	45	43	45	43	42	43	42	41	42	41	41	40														
3	47	44	42	40	46	43	41	40	42	40	39	41	40	39	40	39	38	37														
4	44	41	39	37	43	41	38	37	40	38	36	39	37	36	38	36	35	35														
5	42	38	36	34	41	38	36	34	37	35	34	36	35	33	36	35	33	32														
6	40	36	34	32	39	36	33	32	35	33	31	35	33	31	34	32	31	30														
7	38	34	31	29	37	34	31	29	33	31	29	33	31	29	32	30	29	28														
8	36	32	29	27	35	31	29	27	31	29	27	30	28	27	30	28	27	26														
9	34	29	27	25	33	29	27	25	29	26	25	28	26	25	28	26	25	24														
10	32	27	25	23	31	27	25	23	27	25	23	27	24	23	26	24	23	22														

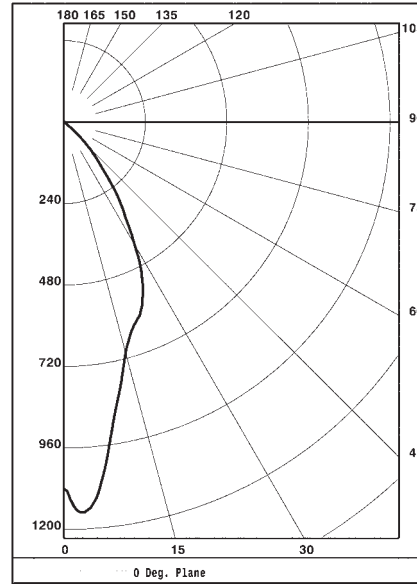
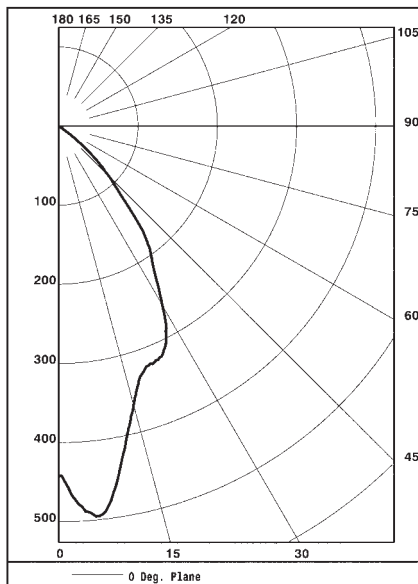
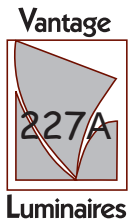

Photometric Information

Product Number: AIC7VF126E1/7200SCL
Frame In Kit: 7" Vertical Mount Fluorescent
Reflector: 7" Vertical Clear "Alzak" Reflector
LTL Test Number: 06145
Lamp(s) Source: (1) 26W PLT 4pin lamp rated at 1800 lumens
Total Luminaire Efficiency: 53.8%
CIE Type: Direct
Luminaire Spacing Criterion: 1.2/1.2
Luminous Diameter: 6.500

Zonal Lumen Summary

ZONE	LUMENS	%LAMP	%FIXTURE
0- 30	559	31.0	57.7
0- 40	834	46.3	86.2
0- 60	968	53.8	100.0
0- 90	968	53.8	100.0
90-180	0	0.0	0.0
0-180	968	53.8	100.0

Cone of Light

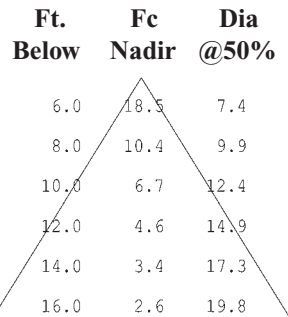

Coefficients of Utilization

RC	80			70			50			30			10			0			
	RW	70	50	30	10	0	RW	70	50	30	10	0	RW	70	50	30	10	0	
0	64	64	64	64	63	63	63	63	60	60	60	57	57	57	55	55	55	54	54
1	61	60	58	57	60	58	57	56	56	55	54	54	53	53	52	52	51	50	50
2	58	55	53	51	57	54	52	51	53	51	50	51	50	49	50	48	48	47	47
3	55	51	49	47	54	51	48	46	49	47	45	48	46	45	47	45	44	43	43
4	52	48	45	42	51	47	44	42	46	43	42	45	43	41	44	42	41	40	40
5	49	44	41	39	48	44	41	38	43	40	38	42	39	38	41	39	37	37	37
6	46	41	38	36	45	41	38	35	40	37	35	39	37	35	39	36	35	34	34
7	44	38	35	33	43	38	35	32	37	34	32	37	34	32	36	34	32	31	31
8	41	35	32	29	40	35	32	29	34	31	29	34	31	29	33	31	29	28	28
9	38	32	29	27	37	32	29	27	32	29	26	31	28	26	31	28	26	25	25
10	36	30	26	24	35	30	26	24	29	26	24	29	26	24	28	26	24	23	23

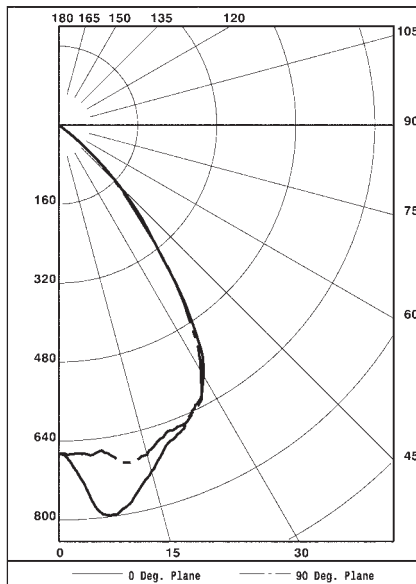

Product Number: AIC7VF132E1/7200SCL
Frame In Kit: 7" Vertical Mount Fluorescent
Reflector: 7" Vertical Clear "Alzak" Reflector
LTL Test Number: 06131
Lamp(s) Source: (1) 32W PLT 4pin lamp rated at 2400 lumens
Total Luminaire Efficiency: 48.1%
CIE Type: Direct
Luminaire Spacing Criterion: 1.2/1.2
Luminous Diameter: 6.500

Zonal Lumen Summary

ZONE	LUMENS	%LAMP	%FIXTURE
0- 30	689	28.7	59.6
0- 40	1002	41.7	86.8
0- 60	1155	48.1	100.0
0- 90	1155	48.1	100.0
90-180	0	0.0	0.0
0-180	1155	48.1	100.0

Cone of Light

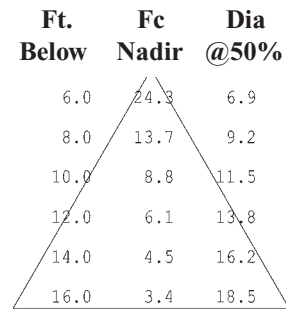

Coefficients of Utilization

RC	80			70			50			30			10			0			
	RW	70	50	30	10	0	RW	70	50	30	10	0	RW	70	50	30	10	0	
0	57	57	57	57	56	56	56	56	53	53	53	51	51	51	49	49	49	48	48
1	55	53	52	51	53	52	51	50	50	49	49	49	48	47	47	46	46	45	45
2	52	50	48	46	51	49	47	45	47	46	44	46	45	44	44	43	43	42	42
3	49	46	44	42	48	45	43	41	44	42	41	43	41	40	42	41	40	39	39
4	47	43	40	38	46	42	40	38	41	39	37	40	38	37	39	38	37	36	36
5	44	40	37	35	43	39	37	35	38	36	34	38	36	34	37	35	34	33	33
6	42	37	34	32	41	37	34	32	36	34	32	35	33	32	35	33	31	31	31
7	39	35	32	29	39	34	31	29	34	31	29	33	31	29	32	30	29	28	28
8	37	32	29	27	36	32	29	27	31	29	27	31	28	27	30	28	26	26	26
9	34	29	26	24	34	29	26	24	29	26	24	28	26	24	28	26	24	23	23
10	32	27	24	22	32	27	24	22	27	24	22	26	24	22	26	23	22	21	21

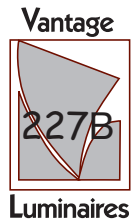
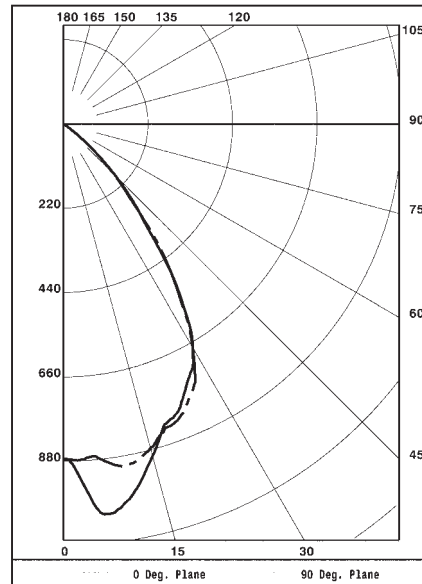

Photometric Information

Product Number: AIC7VF142E1/7200SCL
Frame In Kit: 7" Vertical Mount Fluorescent
Reflector: 7" Vertical Clear "Alzak" Reflector
LTL Test Number: 06132
Lamp(s) Source: (1) 42W PLT 4pin lamp rated at 3200 lumens
Total Luminaire Efficiency: 37.3%
CIE Type: Direct
Luminaire Spacing Criterion: 1.1/1.1
Luminous Diameter: 6.500

Zonal Lumen Summary

ZONE	LUMENS	%LAMP	%FIXTURE
0- 30	783	24.5	65.5
0- 40	1083	33.8	90.6
0- 60	1195	37.3	100.0
0- 90	1195	37.3	100.0
90-180	0	0.0	0.0
0-180	1195	37.3	100.0

Cone of Light

Ft. Below	Fc Nadir	Dia @50%
6.0	29.2	6.4
8.0	16.4	8.6
10.0	10.5	10.7
12.0	7.3	12.9
14.0	5.4	15.0
16.0	4.1	17.2

Coefficients of Utilization

RC	80				70				50				30				10				0	
RW	70	50	30	10	70	50	30	10	50	30	10	50	30	10	50	30	10	50	30	10	0	
0	44	44	44	44	43	43	43	43	41	41	41	40	40	40	38	38	38	37				
1	43	42	41	40	42	41	40	39	39	39	38	38	37	37	37	36	36	35				
2	40	39	37	36	40	38	37	36	37	36	35	36	35	34	35	34	33	33				
3	39	36	34	33	38	36	34	33	35	33	32	34	33	32	33	32	31	31				
4	37	34	32	30	36	33	31	30	33	31	30	32	30	29	31	30	29	28				
5	35	32	29	28	34	31	29	28	30	29	27	30	28	27	29	28	27	26				
6	33	30	27	26	32	29	27	26	29	27	26	28	27	25	28	26	25	25				
7	31	28	25	24	31	27	25	24	27	25	24	27	25	24	26	25	23	23				
8	29	26	23	22	29	26	23	22	25	23	22	25	23	22	24	23	22	21				
9	28	24	22	20	27	24	21	20	23	21	20	23	21	20	23	21	20	19				
10	26	22	20	18	26	22	20	18	22	20	18	21	20	18	21	19	18	18				

