

Architectural Grade

Job Name _____

Type _____

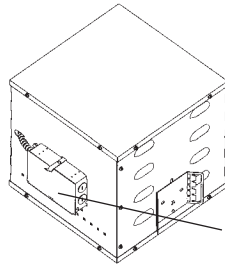
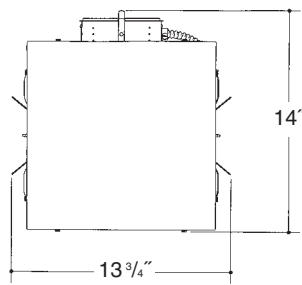

**6" V.F. 1 LT
OPEN
IC-RATED**

Heavy gauge electrogalvanized steel junction box, prewired and grounded with easy access from below, listed for through branch circuit wiring.

Aluminum heat sink socket cup with Zinc plated steel hardware and spring steel clips for fast assembly. *UL Listed* socket.

IC-Rated formed, vented, aluminum housing.

Adjustable height electrogalvanized plated steel mounting ears with cutouts for various mounting methods. Standard bars (included) are innovative and incorporate rigid formed cross sections, joist positioning tabs, integral nails, auxiliary nailholes, T-Bar slots and holes for locking bars to T-Bar using #8 self-tapping screws (by others). Bars extend 14"-24". Ears will also accept Caddy Bar #520 for fast installation in T-Bar ceilings, bars extend 27".

Electronic ballast, Class P, 50/60 HZ-120/277, Programmed Start, thermally protected, 98% Power Factor, 1.00 Ballast Factor, <10% THD, Class A sound rated. Minimum starting temperature -18°C/0°F. *UL Listed* component.

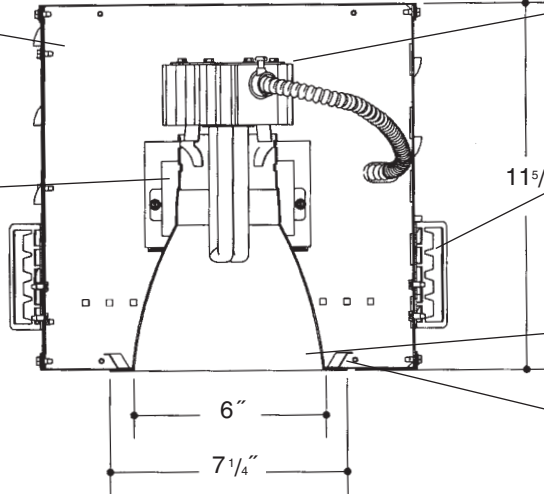

Heavy gauge spun aluminum low iridescent reflector with self trimming white painted flange. Polished Flange available.

Electrogalvanized plated steel frame.

Rough in Kit – 6" Vertical Fluorescent 1-Lamp IC-Rated (Compact Fluorescent Twin, Quad or Triple Tube)

Catalog Number **AIC6VF1**

AIC6VF1

Wattage	Ballast	Voltage	Options
42W MAX. PLT	E	1	F
32W PLT	DA	2	PR
26W DTT, PLT		3	EMI
18W DTT, PLT		4	
13"W TT, DTT			

Ballast		
E	Electronic	(4 Pin Lamp)
DA	Dimming - Advance Mark X	(4 Pin Lamp)
*	13W Advance Mark VII Only	
Voltage		
1	120 Volts	
2	277 Volts	
3	347 Volts (Electronic Ballast Only)	
4	208 Volts (Electronic Ballast Only)	
Options ▲		
F	Fused	
PR	Plaster Ring	
EMI	Internal Mounted Emergency Test Switch	

2-Lamp Not Available in Triple Tube

2-Lamp – Replace AIC6VF1 with AIC6VF2

Electronic Multi-Tap Ballast 120V Thru 277V Factory Standard

Finishing Kit – 6" Vertical Fluorescent Open Reflector##

Catalog Number **6002**

6002

Finish	Options
SCL	PF
SGO	GSK
WHT	

Finish (Factory Standard)	
SCL	Specular Clear "Alzak" with White Flange
SGO	Specular Gold "Alzak" with White Flange
WHT	White Reflector with White Flange

Options ▲	
PF	High Polished Flange
GSK	Neoprene Foam Single Gasketing

Consult Factory for Lensed Reflectors or Wall Washers _____

Features

Manufactured and Listed to UL 1598, ETL and CSA standards. Suitable for Damp Locations Wet location under covered ceiling



▲ See Options and Finishes pages for a list of additional finishes and equipment.

Vantage reserves the right to change components, finishes or design details in any manner which does not alter the installed appearance or reduce performance and intended function.

Vantage



Luminaires

76 Community Avenue Plainfield, CT 06374
voice (860)564.4512 fax (860)564.4854
www.vantageitg.com

06/07

Photometric Information

Product Number: AIC6VF113E1/6002SCL
Frame In Kit: 6" Vertical Mount Fluorescent
Reflector: 6" Vertical Clear "Alzak" Reflector
LTL Test Number: 05650
Lamp(s) Source: (1) 13W DTT 4pin lamp rated at 900 lumens
Total Luminaire Efficiency: 48.5%
CIE Type: Direct
Luminaire Spacing Criterion: 0.8
Luminous Diameter: 6.0

Zonal Lumen Summary

ZONE	LUMENS	%LAMP	%FIXTURE
0- 30	268	29.8	61.4
0- 40	382	42.5	87.6
0- 60	436	48.5	100.0
0- 90	436	48.5	100.0
90-180	0	0.0	0.0
0-180	436	48.5	100.0

Cone of Light

Ft. Below	Fc Nadir	Dia @50%
6.0	12.8	4.9
8.0	7.2	6.5
10.0	4.6	8.2
12.0	3.2	9.8
14.0	2.3	11.4
16.0	1.8	13.1

Coefficients of Utilization

RC	80				70				50				30				10				0
RW	70	50	30	10	70	50	30	10	50	30	10	50	30	10	50	30	10	50	30	10	0
0	58	58	58	58	56	56	56	56	54	54	54	52	52	52	49	49	49	48			
1	55	54	53	52	54	53	52	51	51	50	49	49	48	48	47	47	46	45			
2	52	50	48	47	51	49	48	46	48	46	45	46	45	44	45	44	43	42			
3	50	47	44	42	49	46	44	42	45	43	41	44	42	41	43	41	40	39			
4	47	43	41	39	46	43	40	39	42	40	38	41	39	38	40	38	37	36			
5	45	41	38	36	44	40	37	35	39	37	35	38	36	35	38	36	34	34			
6	42	38	35	33	42	38	35	33	37	34	33	36	34	32	36	34	32	31			
7	40	35	32	30	39	35	32	30	34	32	30	34	32	30	33	31	30	29			
8	38	33	30	28	37	33	30	28	32	29	28	32	29	28	31	29	27	27			
9	35	30	27	25	35	30	27	25	30	27	25	29	27	25	29	27	25	24			
10	33	28	25	23	33	28	25	23	28	25	23	27	25	23	27	25	23	22			

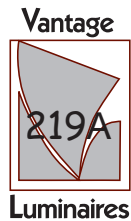
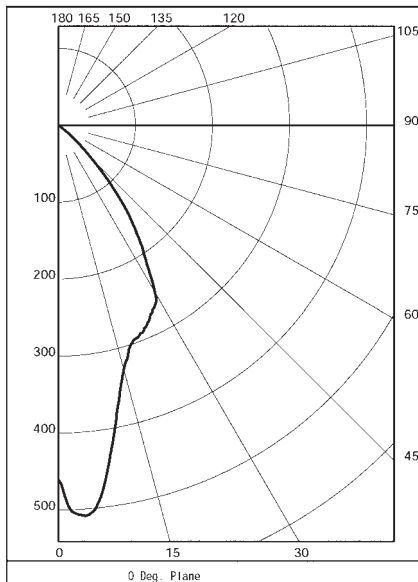

Product Number: AIC6VF118E1/6002SCL
Frame In Kit: 6" Vertical Mount Fluorescent
Reflector: 6" Vertical Clear "Alzak" Reflector
LTL Test Number: 05651
Lamp(s) Source: (1) 18W DTT 4pin lamp rated at 1250 lumens
Total Luminaire Efficiency: 54.5%
CIE Type: Direct
Luminaire Spacing Criterion: 0.9
Luminous Diameter: 6.0

Zonal Lumen Summary

ZONE	LUMENS	%LAMP	%FIXTURE
0- 30	361	28.9	53.0
0- 40	534	42.7	78.4
0- 60	681	54.5	100.0
0- 90	681	54.5	100.0
90-180	0	0.0	0.0
0-180	681	54.5	100.0

Cone of Light

Ft. Below	Fc Nadir	Dia @50%
6.0	16.9	5.1
8.0	9.5	6.8
10.0	6.1	8.5
12.0	4.2	10.2
14.0	3.1	11.9
16.0	2.4	13.6

Coefficients of Utilization

RC	80				70				50				30				10				0
RW	70	50	30	10	70	50	30	10	50	30	10	50	30	10	50	30	10	50	30	10	0
0	65	65	65	65	64	64	64	64	61	61	61	58	58	58	56	56	56	55			
1	62	60	59	58	61	59	58	57	57	56	55	55	54	53	53	52	52	51			
2	59	56	54	52	57	55	53	51	53	51	50	51	50	49	50	49	48	47			
3	55	52	49	47	54	51	48	46	49	47	45	48	46	45	47	45	44	43			
4	52	48	45	42	51	47	44	42	46	43	41	45	43	41	44	42	40	39			
5	49	44	41	38	48	44	40	38	43	40	38	42	39	37	41	39	37	36			
6	46	41	37	35	45	40	37	35	40	37	34	39	36	34	38	36	34	33			
7	43	38	34	32	43	37	34	32	37	34	31	36	33	31	35	33	31	30			
8	40	35	31	29	40	34	31	28	34	31	28	33	30	28	33	30	28	27			
9	38	32	28	26	37	31	28	26	31	28	25	30	27	25	30	27	25	24			
10	35	29	26	23	35	29	26	23	29	25	23	28	25	23	28	25	23	22			

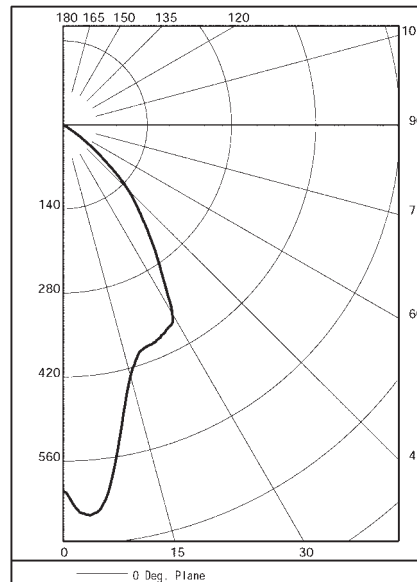

Photometric Information

Product Number: AIC6VF126E1/6002SCL
Frame In Kit: 6" Vertical Mount Fluorescent
Reflector: 6" Vertical Clear "Alzak" Reflector
LTL Test Number: 05652
Lamp(s) Source: (1) 26W DTT 4pin lamp rated at 1800 lumens
Total Luminaire Efficiency: 53.6%
CIE Type: Direct
Luminaire Spacing Criterion: 0.9
Luminous Diameter: 6.0

Zonal Lumen Summary

ZONE	LUMENS	%LAMP	%FIXTURE
0- 30	439	24.4	45.4
0- 40	669	37.2	69.3
0- 60	949	52.7	98.2
0- 90	966	53.6	100.0
90-180	0	0.0	0.0
0-180	966	53.6	100.0

Cone of Light

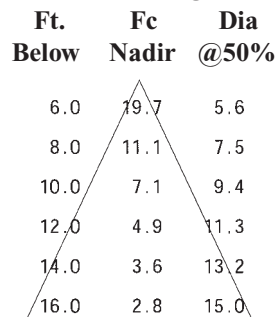

Coefficients of Utilization

RC	80				70				50				30				10				0
RW	70	50	30	10	70	50	30	10	50	30	10	50	30	10	50	30	10	50	30	10	0
0	64	64	64	64	62	62	62	62	60	60	60	57	57	57	55	55	55	54	54	54	54
1	60	59	57	56	59	58	56	55	55	54	53	53	53	52	52	51	50	49	49	49	49
2	57	54	52	49	56	53	51	49	51	49	48	50	48	47	48	47	46	45	45	45	45
3	53	50	46	44	52	49	46	44	47	45	43	46	44	42	45	43	42	41	41	41	41
4	50	45	42	39	49	45	41	39	43	41	39	42	40	38	41	39	38	37	37	37	37
5	47	41	38	35	46	41	37	35	40	37	35	39	36	34	38	36	34	33	33	33	33
6	44	38	34	32	43	38	34	31	37	34	31	36	33	31	35	33	31	30	30	30	30
7	41	35	31	28	40	34	31	28	34	30	28	33	30	28	32	30	28	27	27	27	27
8	38	32	28	25	37	31	28	25	31	27	25	30	27	25	29	27	25	24	24	24	24
9	35	29	25	22	34	28	25	22	28	25	22	27	24	22	27	24	22	21	21	21	21
10	33	26	23	20	32	26	22	20	26	22	20	25	22	20	25	22	20	19	19	19	19

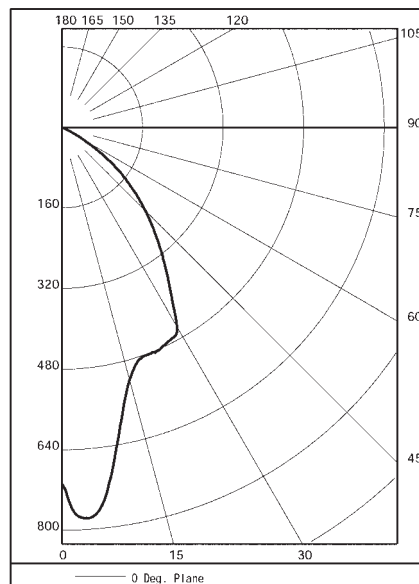

Product Number: AIC6VF132E1/6002SCL
Frame In Kit: 6" Vertical Mount Fluorescent
Reflector: 6" Vertical Clear "Alzak" Reflector
LTL Test Number: 05653
Lamp(s) Source: (1) 32W PLT 4pin lamp rated at 2400 lumens
Total Luminaire Efficiency: 54.8%
CIE Type: Direct
Luminaire Spacing Criterion: 1.0
Luminous Diameter: 6.0

Zonal Lumen Summary

ZONE	LUMENS	%LAMP	%FIXTURE
0- 30	698	29.1	53.1
0- 40	1047	43.6	79.6
0- 60	1315	54.8	100.0
0- 90	1315	54.8	100.0
90-180	0	0.0	0.0
0-180	1315	54.8	100.0

Cone of Light

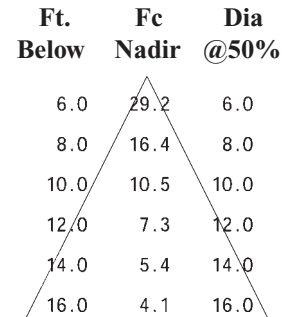

Coefficients of Utilization

RC	80				70				50				30				10				0
RW	70	50	30	10	70	50	30	10	50	30	10	50	30	10	50	30	10	50	30	10	0
0	65	65	65	65	64	64	64	64	61	61	61	58	58	58	56	56	56	55	55	55	55
1	62	60	59	58	61	59	58	57	57	56	55	55	54	54	53	53	52	51	51	51	51
2	59	56	54	52	58	55	53	51	53	52	50	52	50	49	50	49	48	47	47	47	47
3	56	52	49	47	54	51	48	46	50	47	46	48	46	45	47	46	44	43	43	43	43
4	52	48	45	42	51	47	44	42	46	44	42	45	43	41	44	42	41	40	40	40	40
5	49	44	41	38	48	44	41	38	43	40	38	42	39	37	41	39	37	36	36	36	36
6	46	41	38	35	46	41	37	35	40	37	35	39	36	34	38	36	34	33	33	33	33
7	44	38	34	32	43	38	34	32	37	34	32	36	33	31	36	33	31	30	30	30	30
8	41	35	31	29	40	35	31	29	34	31	29	33	30	28	33	30	28	27	27	27	27
9	38	32	28	26	37	32	28	26	31	28	26	31	28	26	30	27	25	25	25	25	25
10	35	29	26	23	35	29	26	23	29	25	23	28	25	23	28	25	23	22	22	22	22

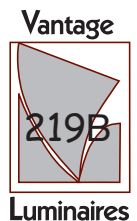
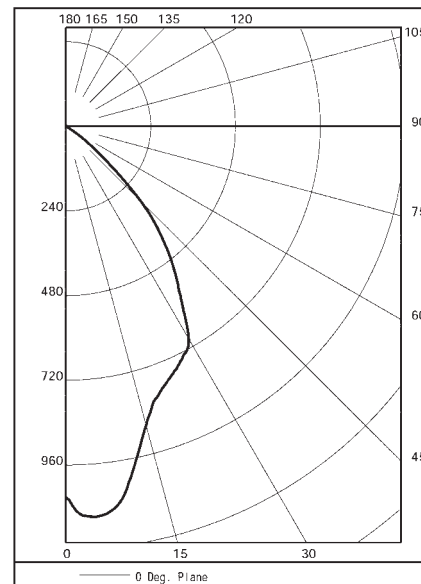

Photometric Information

Product Number: AIC6VF142E1/6002SCL
Frame In Kit: 6" Vertical Mount Fluorescent
Reflector: 6" Vertical Clear "Alzak" Reflector
LTL Test Number: 05654
Lamp(s) Source: (1) 42W PLT 4pin lamp rated at 3200 lumens
Total Luminaire Efficiency: 54.0%
CIE Type: Direct
Luminaire Spacing Criterion: 1.1
Luminous Diameter: 6.0

Zonal Lumen Summary

ZONE	LUMENS	%LAMP	%FIXTURE
0- 30	757	23.7	43.8
0- 40	1167	36.5	67.5
0- 60	1699	53.1	98.2
0- 90	1729	54.0	100.0
90-180	0	0.0	0.0
0-180	1729	54.0	100.0

Cone of Light

Ft. Fc Dia
Below Nadir @50%

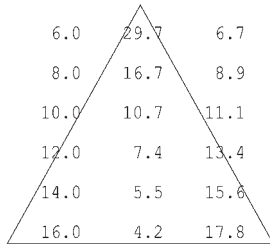

Coefficients of Utilization

FC	80				70				50				30				10				0
	70	50	30	10	70	50	30	10	50	30	10	50	30	10	50	30	10	0			
0	64	64	64	64	63	63	63	63	60	60	60	57	57	57	55	55	55	54			
1	61	59	58	56	59	58	57	55	56	55	54	54	53	52	52	51	50	49			
2	57	54	52	50	56	53	51	49	51	50	48	50	48	47	48	47	46	45			
3	54	50	46	44	53	49	46	44	47	45	43	46	44	42	45	43	42	41			
4	50	45	42	39	49	45	41	39	43	41	38	42	40	38	41	39	37	37			
5	47	41	38	35	46	41	37	35	40	37	34	39	36	34	38	35	34	33			
6	44	38	34	31	43	37	34	31	36	33	31	36	33	31	35	32	30	29			
7	41	34	31	28	40	34	30	28	33	30	28	33	30	27	32	29	27	26			
8	38	31	27	25	37	31	27	25	30	27	24	30	27	24	29	26	24	23			
9	35	28	24	22	34	28	24	22	27	24	22	27	24	22	26	24	21	21			
10	32	26	22	20	32	26	22	19	25	22	19	25	22	19	24	21	19	18			

