

C o m m e r c i a l G r a d e

Job Name _____

Type _____

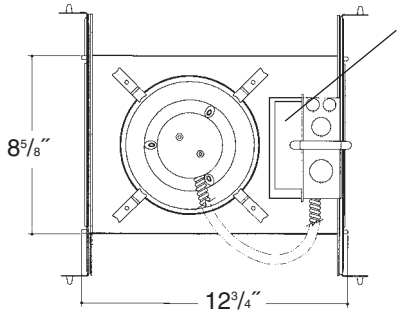

Electronic ballast, Class P, 50/60 HZ-120/277, Programmed Start, thermally protected, 98% Power Factor, 1.00 Ballast Factor, <10% THD, Class A sound rated. Minimum starting temperature -18°C/0°F.
Magnetic ballast, High Power Factor, thermally protected, minimum starting temperature 10°C/50°F.
UL Listed component.

7" V.F. 1 LT LENSED

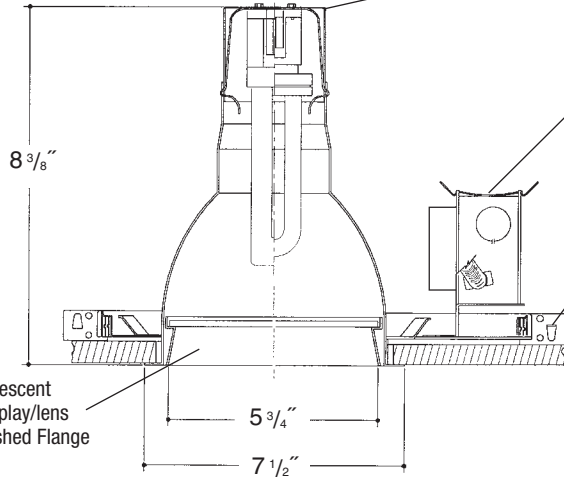

Heavy gauge spun aluminum low iridescent reflector with self trimming flanged splay/lens holder and white painted flange. Polished Flange available. Safety chain provided.

Aluminum socket cup with spring steel snap-in clips for fast assembly. *UL Listed* socket.

Heavy gauge electrogalvanized steel junction box, prewired and grounded with easy access from below. Listed for through branch circuit wiring.

Electrogalvanized steel frame components with spring steel reflector clips for fast assembly of reflector. Innovative, rigid bar hangers incorporate formed cross sections, joist positioning tabs, integral nails, auxiliary nailholes, T-Bar slots and holes for locking bars to T-Bar using #8 self-tapping screws (by others). Bars extend 14"-24". Frame will also accept Caddy Bar #517B for fast installation in drop-in ceilings, bars extend 27".

Rough in Kit – 7" Vertical Fluorescent 1-Lamp (Compact Fluorescent Twin, Quad or Triple Tube)

Catalog Number **7VF1** _____

7VF1	Wattage	Ballast	Voltage	Options
	42W MAX. PLT	E	1	EM
	32W PLT	H	2	F
	26W DTT, PLT	DA	3	R
	18W DTT PLT	DL	4	
	13"W TT, DTT			

Ballast		
E	Electronic	(4 Pin Lamp)
H	High Power Factor	(2 Pin Lamp)
DA	Dimming - Advance Mark X	(4 Pin Lamp)
DL	Dimming - Lutron	(4 Pin Lamp)
*	13W Advance Mark VII Only	
Voltage		
1	120 Volts	
2	277 Volts	
3	347 Volts (Electronic Ballast Only)	
4	208 Volts (Electronic Ballast Only)	
Options ▲		
EM	Emergency Battery	
F	Fused	
R	Remodeler	

2-Lamp Not Available in Triple Tube

2-Lamp – Replace 7VF1 with 7VF2

Electronic Multi-Tap Ballast 120V Thru 277V Factory Standard

Finishing Kit – 7" Vertical Fluorescent Lensed Reflector – clear reflector standard with self trim flange

Catalog Number **72** _____

72	Lens	Finish	Options
	7211 - Tempered Clear Lens	SCL	PF
	7214 - Tempered Prismatic Lens (C73 Pattern)	SGO	DGSK
	7215 - Opal Acrylic Dome (Shower Light)	WHT	
	7216 - Fresnel Lens		
	7218 - Flat Alba Lens		
	7219 - Drop Opal Lens		

Finish (Factory Standard)	
SCL	Specular Clear "Alzak" Splay with White Flange
SGO	Specular Gold "Alzak" Splay with White Flange
WHT	White Splay with White Flange
Options ▲	
PF	High Polished Flange
DGSK	Neoprene Foam Double Gasketing

Features

Manufactured and Listed to UL 1598, ETL and CSA standards.
Suitable for Damp Locations
Wet location under covered ceiling



▲ See Options and Finishes pages for a list of additional finishes and equipment.

Vantage reserves the right to change components, finishes or design details in any manner which does not alter the installed appearance or reduce performance and intended function.

Vantage

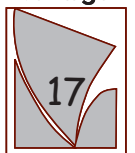

Luminares

76 Community Avenue Plainfield, CT 06374
voice (860)564.4512 fax (860)564.4854
www.vantageitg.com

02/09

Photometric Information

Product Number: 7VF113E/7214SCL
Frame In Kit: 7" Vertical Mount Fluorescent
Reflector: 7" Vertical Clear "Alzak" Reflector with prismatic glass lens and specular clear "Alzak" splay
LTL Test Number: 05309
Lamp(s) Source: (1) 13W 4 pin lamp rated at 900 lumens
Total Luminaire Efficiency: 38.7%
CIE Type: Direct
Luminaire Spacing Criterion: 0.9
Luminous Diameter: 5.250

Zonal Lumen Summary

ZONE	LUMENS	%LAMP	%FIXTURE
0- 30	201	22.3	57.5
0- 40	273	30.3	78.3
0- 60	334	37.1	95.7
0- 90	349	38.7	100.0
90-180	0	0.0	0.0
0-180	349	38.7	100.0

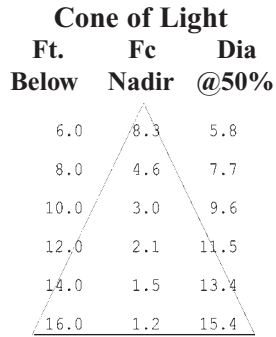

Coefficients of Utilization

RC	80			70			50			30			10			0					
RW	70	50	30	10	70	50	30	10	50	30	10	50	30	10	50	30	10	50	30	10	0
0	46	46	46	46	45	45	45	45	43	43	43	41	41	41	39	39	39	39	39	39	39
1	44	43	42	41	43	42	41	40	40	39	39	39	38	38	37	37	36	36	36	36	36
2	41	39	37	36	40	39	37	36	37	36	35	36	35	34	35	34	33	33	33	33	33
3	39	36	34	32	38	36	34	32	35	33	32	34	32	31	33	32	31	30	30	30	30
4	37	33	31	29	36	33	31	29	32	30	29	31	30	28	31	29	28	27	27	27	27
5	34	31	28	27	34	30	28	26	30	28	26	29	27	26	28	27	26	25	25	25	25
6	33	29	26	24	32	28	26	24	28	26	24	27	25	24	27	25	24	23	23	23	23
7	31	27	24	22	30	26	24	22	26	24	22	25	23	22	25	23	22	21	21	21	21
8	29	25	22	20	28	24	22	20	24	22	20	24	22	20	23	21	20	19	19	19	19
9	27	23	20	18	26	23	20	18	22	20	18	22	20	18	21	20	18	18	18	18	18
10	25	21	19	17	25	21	18	17	21	18	17	20	18	17	20	18	17	16	16	16	16

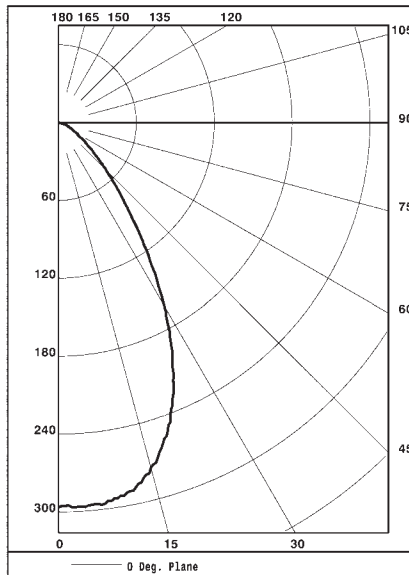

Product Number: 7VF213E/7214SCL
Frame In Kit: 7" Vertical Mount Fluorescent
Reflector: 7" Vertical Clear "Alzak" Reflector with prismatic glass lens and specular clear "Alzak" splay
LTL Test Number: 05311
Lamp(s) Source: (2) 13W 4 pin lamp rated at 900 lumens each
Total Luminaire Efficiency: 32.7%
CIE Type: Direct
Luminaire Spacing Criterion: 1.1/1.0
Luminous Diameter: 5.250

Zonal Lumen Summary

ZONE	LUMENS	%LAMP	%FIXTURE
0- 30	320	17.8	54.5
0- 40	446	24.8	75.8
0- 60	559	31.1	95.0
0- 90	588	32.7	100.0
90-180	0	0.0	0.0
0-180	588	32.7	100.0

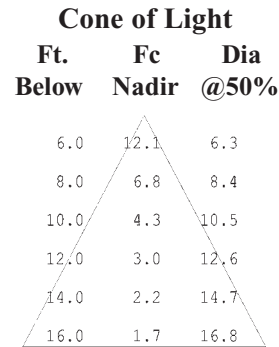

Coefficients of Utilization

RC	80			70			50			30			10			0					
RW	70	50	30	10	70	50	30	10	50	30	10	50	30	10	50	30	10	50	30	10	0
0	39	39	39	39	38	38	38	38	36	36	36	35	35	35	33	33	33	33	33	33	33
1	37	36	35	34	36	35	34	34	34	33	33	33	32	32	31	31	31	30	30	30	30
2	35	33	31	30	34	32	31	30	31	30	29	30	29	29	29	29	28	27	27	27	27
3	33	30	29	27	32	30	28	27	29	28	26	28	27	26	27	26	26	25	25	25	25
4	31	28	26	24	30	28	26	24	27	25	24	26	25	24	25	24	23	23	23	23	23
5	29	26	24	22	28	25	23	22	25	23	22	24	23	21	24	22	21	21	21	21	21
6	27	24	22	20	27	24	21	20	23	21	20	23	21	20	22	21	20	19	19	19	19
7	25	22	20	18	25	22	20	18	21	19	18	21	19	18	21	19	18	17	17	17	17
8	24	20	18	17	23	20	18	17	20	18	16	19	18	16	19	17	16	16	16	16	16
9	22	19	16	15	22	18	16	15	18	16	15	18	16	15	18	16	15	14	14	14	14
10	21	17	15	14	21	17	15	14	17	15	14	17	15	13	16	15	13	13	13	13	13

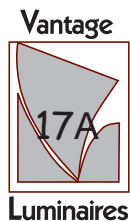
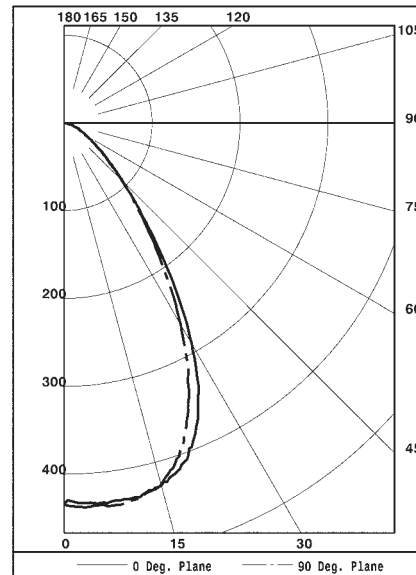

Photometric Information

Product Number: 7VF118E/7214SCL
Frame In Kit: 7" Vertical Mount Fluorescent
Reflector: 7" Vertical Clear "Alzak" Reflector with prismatic glass lens and specular clear "Alzak" splay
LTL Test Number: 05306
Lamp(s) Source: (1) 18W 4 pin lamp rated at 1250 lumens
Total Luminaire Efficiency: 41.6%
CIE Type: Direct
Luminaire Spacing Criterion: 1.0
Luminous Diameter: 5.250

Zonal Lumen Summary

ZONE	LUMENS	%LAMP	%FIXTURE
0- 30	276	22.1	53.1
0- 40	390	31.2	75.1
0- 60	496	39.7	95.6
0- 90	519	41.6	100.0
90-180	0	0.0	0.0
0-180	519	41.6	100.0

Cone of Light

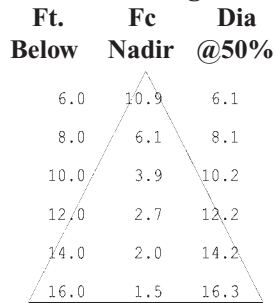

Coefficients of Utilization

RC	80				70				50				30				10				0
RW	70	50	30	10	70	50	30	10	50	30	10	50	30	10	50	30	10	50	30	10	0
0	49	49	49	49	48	48	48	48	46	46	46	44	44	44	42	42	42	42	42	42	0
1	47	46	44	43	46	45	44	43	43	42	41	41	41	40	40	39	39	38	38	38	0
2	44	42	40	38	43	41	39	38	40	38	37	39	37	36	37	36	36	35	35	35	0
3	42	39	36	34	41	38	36	34	37	35	34	36	34	33	35	34	32	32	32	32	0
4	39	35	33	31	38	35	33	31	34	32	30	33	31	30	32	31	30	29	29	29	0
5	37	33	30	28	36	32	30	28	31	29	27	31	29	27	30	28	27	26	26	26	0
6	34	30	27	25	34	30	27	25	29	27	25	29	26	25	28	26	25	24	24	24	0
7	32	28	25	23	32	28	25	23	27	25	23	27	24	23	26	24	23	22	22	22	0
8	30	26	23	21	30	25	23	21	25	22	21	24	22	21	24	22	21	20	20	20	0
9	28	24	21	19	28	23	21	19	23	20	19	22	20	19	22	20	19	18	18	18	0
10	26	22	19	17	26	22	19	17	21	19	17	21	19	17	20	18	17	16	16	16	0

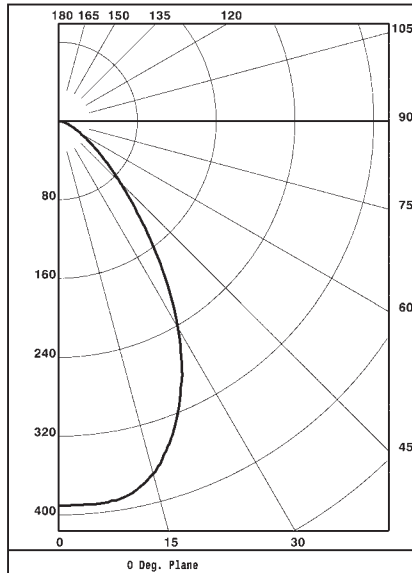

Product Number: 7VF126E/7214SCL
Frame In Kit: 7" Vertical Mount Fluorescent
Reflector: 7" Vertical Clear "Alzak" Reflector with prismatic glass lens and specular clear "Alzak" splay
LTL Test Number: 05307*
Lamp(s) Source: (1) 26W 4 pin lamp rated at 1800 lumens
Total Luminaire Efficiency: 41.6%
CIE Type: Direct
Luminaire Spacing Criterion: 1.0
Luminous Diameter: 5.250

Zonal Lumen Summary

ZONE	LUMENS	%LAMP	%FIXTURE
0- 30	397	22.1	53.0
0- 40	561	31.2	75.0
0- 60	715	39.7	95.5
0- 90	748	41.6	100.0
90-180	0	0.0	0.0
0-180	748	41.6	100.0

Cone of Light

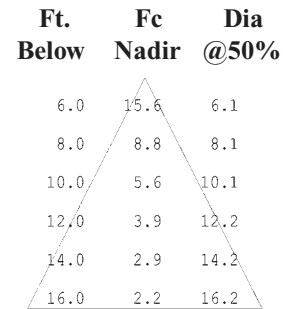

Coefficients of Utilization

RC	80				70				50				30				10				0
RW	70	50	30	10	70	50	30	10	50	30	10	50	30	10	50	30	10	50	30	10	0
0	49	49	49	49	48	48	48	48	46	46	46	44	44	44	42	42	42	42	42	42	0
1	47	46	44	43	46	45	44	43	43	42	41	41	41	40	40	39	39	38	38	38	0
2	44	42	40	38	43	41	39	38	40	38	37	39	37	36	37	36	36	35	35	35	0
3	42	39	36	34	41	38	36	34	37	35	34	36	34	33	35	34	32	32	32	32	0
4	39	35	33	31	38	35	33	31	34	32	30	33	31	30	32	31	30	29	29	29	0
5	37	33	30	28	36	32	30	28	31	29	27	31	29	27	30	28	27	26	26	26	0
6	34	30	27	25	34	30	27	25	29	27	25	29	26	25	28	26	25	24	24	24	0
7	32	28	25	23	32	28	25	23	27	25	23	27	24	23	26	24	23	22	22	22	0
8	30	26	23	21	30	25	23	21	25	22	21	24	22	21	24	22	21	20	20	20	0
9	28	24	21	19	28	23	21	19	23	20	19	22	20	19	22	20	19	18	18	18	0
10	26	22	19	17	26	22	19	17	21	19	17	21	19	17	20	18	17	16	16	16	0

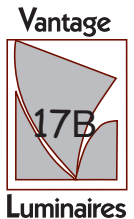
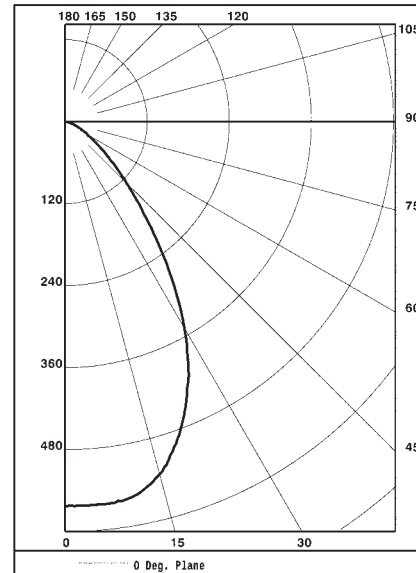

Photometric Information

Product Number: 7VF126E/7214SCL
Frame In Kit: 7" Vertical Mount Fluorescent
Reflector: 7" Vertical Clear "Alzak" Reflector with prismatic glass lens and specular clear "Alzak" splay
LTL Test Number: 05303
Lamp(s) Source: (1) 26W DT 4 pin lamp rated at 1800 lumens
Total Luminaire Efficiency: 35.9%
CIE Type: Direct
Luminaire Spacing Criterion: 0.9
Luminous Diameter: 5.250

Zonal Lumen Summary

ZONE	LUMENS	%LAMP	%FIXTURE
0- 30	370	20.6	57.3
0- 40	504	28.0	78.0
0- 60	617	34.3	95.6
0- 90	646	35.9	100.0
90-180	0	0.0	0.0
0-180	646	35.9	100.0

Cone of Light

Ft. Below	Fc Nadir	Dia @50%
6.0	15.1	5.9
8.0	8.5	7.8
10.0	5.4	9.8
12.0	3.8	11.7
14.0	2.8	13.7
16.0	2.1	15.6

Coefficients of Utilization

RC	80				70				50				30				10				0
RW	70	50	30	10	70	50	30	10	50	30	10	50	30	10	50	30	10	50	30	10	0
0	43	43	43	43	42	42	42	42	40	40	40	38	38	38	37	37	37	36			
1	40	39	38	38	40	39	38	37	37	36	36	36	35	35	35	34	34	33			
2	38	36	35	33	37	36	34	33	34	33	32	33	32	32	32	31	30				
3	36	34	32	30	35	33	31	30	32	31	29	31	30	29	30	29	28				
4	34	31	29	27	33	31	28	27	30	28	27	29	27	26	28	27	26				
5	32	29	26	24	31	28	26	24	28	26	24	27	25	24	26	25	24				
6	30	27	24	22	30	26	24	22	26	24	22	25	23	22	25	23	22				
7	28	25	22	21	28	24	22	21	24	22	20	23	22	20	23	21	20				
8	27	23	20	19	26	23	20	19	22	20	19	22	20	19	21	20	18				
9	25	21	19	17	24	21	19	17	20	18	17	20	18	17	20	18	17				
10	23	19	17	16	23	19	17	15	19	17	15	19	17	15	18	17	15				

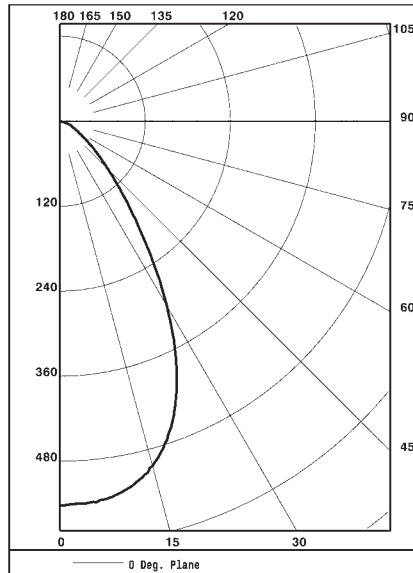

Product Number: 7VF142E/7214SCL
Frame In Kit: 7" Vertical Mount Fluorescent
Reflector: 7" Vertical Clear "Alzak" Reflector with prismatic glass lens and specular clear "Alzak" splay
LTL Test Number: 05302
Lamp(s) Source: (1) 42W 4 pin lamp rated at 3200 lumens
Total Luminaire Efficiency: 30.4%
CIE Type: Direct
Luminaire Spacing Criterion: 1.1
Luminous Diameter: 5.250

Zonal Lumen Summary

ZONE	LUMENS	%LAMP	%FIXTURE
0- 30	465	14.5	47.8
0- 40	688	21.5	70.6
0- 60	920	28.8	94.5
0- 90	974	30.4	100.0
90-180	0	0.0	0.0
0-180	974	30.4	100.0

Cone of Light

Ft. Below	Fc Nadir	Dia @50%
6.0	17.8	6.4
8.0	10.0	8.6
10.0	6.4	10.7
12.0	4.4	12.8
14.0	3.3	15.0
16.0	2.5	17.1

Coefficients of Utilization

RC	80				70				50				30				10				0
RW	70	50	30	10	70	50	30	10	50	30	10	50	30	10	50	30	10	50	30	10	0
0	36	36	36	36	35	35	35	35	34	34	34	32	32	32	31	31	31	30			
1	34	33	32	32	33	33	32	31	31	31	30	30	30	29	29	29	28				
2	32	30	29	28	31	30	29	27	29	28	27	28	27	26	27	26	25				
3	30	28	26	25	30	27	26	24	27	25	24	26	25	24	25	24	23				
4	28	26	24	22	28	25	23	22	24	23	22	24	22	21	23	22	21				
5	26	23	21	20	26	23	21	20	22	21	19	22	20	19	21	20	19				
6	25	21	19	18	24	21	19	18	21	19	18	20	19	17	20	18	17				
7	23	20	18	16	23	19	17	16	19	17	16	19	17	16	18	17	16				
8	22	18	16	14	21	18	16	14	17	16	14	17	15	14	17	15	14				
9	20	16	14	13	20	16	14	13	16	14	13	16	14	13	15	14	13				
10	19	15	13	12	18	15	13	12	15	13	12	14	13	11	14	13	11				

